

HEALTHCARE PRODUCTS CATALOGUE





Healthcare Products Catalogue

Brand of Premium Quality
Surgical (Reusable & Disposable), Dental, Veterinary, Beauty instruments
&
Medical Disposable Items

IGSAR GROUP
Igsar Group Ltd., Canada
Head Office: 6158,
Duford Drive, Mississauga
Ontario L5V 1A6
Canada
T: + 1 647 454 8383
www.igsar-group.com
info@igsar-group.com



INTRODUCTION

M/S Igsar is a diversified business group domiciled in Canada. Igsar is involved in International Trade, Real Estate, Investments, I.C.T., Healthcare and consulting streams. Igsar is a quality brand of surgical instruments (reusable & disposable), Medical Disposable items and other products for general procedures, surgery and dental clinic needs. Igsar ensures that its products are manufactured using high quality raw materials and state of the art manufacturing process, under a stringent quality control and sterile environment. Since healthcare products play a critical role in the demanding field of medicine, our primary objective is to get manufactured and supply products that meet strict hygienic standards. Igsar is currently expanding its distribution markets globally.

At Igsar customer experience and satisfaction is placed at the core value of business. Efforts are geared towards understanding customer needs and requirements to cater quality products compliant with the highest industry standards. Igsar strives to create value for all stakeholders, by being a subscriber of latest trends and innovation. It prides in introducing the most practical and state-of-the-art products to the market.

Assured with quality confidence, backed by dexterity and skilled craftsmanship, Igsar aspires to become one of the leading suppliers of choice in the Surgical Instrument and Medical Disposables industry. Igsar ensures its products are trustworthy, engineered to perfection and have been grounded on the substratum of invaluable inputs made by its customers. What distinguishes Igsar from others is its synergistic and focused approach towards satisfying clients needs in line with international marketing standards.

Igsar also provides Healthcare Consultancy services. These services include Medical Planning, Primary Healthcare, Healthcare Financing, Clinical Knowledge Process Outsourcing and Hospital Management etc

IGSAR SPIRIT

Igsar is endeavoring into international markets with true entrepreneurial spirit. It is committed to stand dependable as a partner in meeting the needs of its clients. Igsar drives excellence in service, quality and trust to be number one.

VISION

Endeavour to build faith, safety and demand worldwide through expertise and latest technology.

MISSION

Create an enduring value through excellence, commitment and high professionalism.

Contents

Section I Surgical Instruments

Diagnostics	1
Scissors	2
Artery Forceps	4
Towel Clamps & Artery Forceps	6
Dressing & Tissue Forceps	8
Retractors	10
Probes	13
Anaesthesia	14
Suture	17
Dressing-Bandage Scissors & Plaster Shears	18
Bone Surgery	19
Cardiovascular Surgery	24
Intestine	26
Urology	27
Gynecology	28
Gynecology / Obstetrics	30
Otology & Rhinology	31
Ophthalmology	34
TC Instruments	37
Dental Forceps	40
Dental Instruments	41
Impression Trays & Syringes	42
Sterilization & Instrument Boxes	43
Round Bowls, Jars & Instrument Trays	44
Containers	45

Contents

Section II Medical Disposable Products

Disposable Syringes/Needles	46
Cannula	47
Disposable Gloves	48
Disposable Catheters	49
Hospital Bed Sheet	50
Hospital Towels	51
Absorbent Cloths (Operation Theater) Patient's Gowns.....	52
Scrub Suits / Lab Coats	53
Non-Woven Products	54
Shoe Cover.....	55
Gauze Swabs/Sponges Sterilized.....	56
Gauze Swabs / Non Sterilized	57
Gauze Bandages.....	58
Absorbent Cotton Wool	59
Abdominal Sponge / Swabs non Sterile.....	60
Abdominal Sponge / Swabs Sterile.....	61
Crepe Bandages.....	62
Medical X-Ray Films.....	63

Section I

SURGICAL INSTRUMENTS

(Reusable & Disposables)

Diagnostics

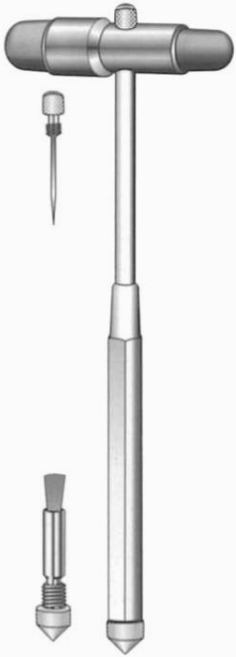

Buck
01-102-18
18 cm / 7"



Taylor
01-103-20
20 cm / 8"

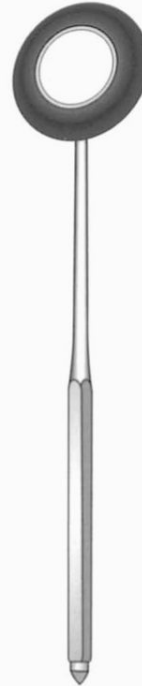

Babinsky
01-106-22
24 cm / 9½"
Metal handle



Vernon
01-108-28
28 cm / 11"



Queen Telescopic
01-110-25



Pinard
01-111-15
14 cm / 5½"
Aluminium
01-112-14
15 cm / 6"
Plastic in different colours



Wartenberg
01-113-19
19 cm / 7½"



National Hospital Patt
01-109-33
33 cm / 13"
Plastic Handle

Scissors



Standard
Straight, Blunt/Blunt

03-101-11	11 cm / 4½"
03-101-13	13 cm / 5"
03-101-14	14 cm / 5½"
03-101-15	15 cm / 6"
03-101-18	18 cm / 7"
03-101-20	20 cm / 8"



Standard
Straight, Sharp/Blunt

03-102-11	11 cm / 4½"
03-102-13	13 cm / 5"
03-102-14	14 cm / 5½"
03-102-15	15 cm / 6"
03-102-18	18 cm / 7"
03-102-20	20 cm / 8"



Standard
Straight, Sharp/Sharp

03-103-11	11 cm / 4½"
03-103-13	13 cm / 5"
03-103-14	14 cm / 5½"
03-103-15	15 cm / 6"
03-103-18	18 cm / 7"
03-103-20	20 cm / 8"



Standard
Curved, Blunt/Blunt

03-104-11	11 cm / 4½"
03-104-13	13 cm / 5"
03-104-14	14 cm / 5½"
03-104-15	15 cm / 6"
03-104-18	18 cm / 7"
03-104-20	20 cm / 8"



Standard
Curved, Sharp/Blunt

03-105-11	11 cm / 4½"
03-105-13	13 cm / 5"
03-105-14	14 cm / 5½"
03-105-15	15 cm / 6"
03-105-18	18 cm / 7"
03-105-20	20 cm / 8"



Standard
Curved, Sharp/Sharp

03-106-11	11 cm / 4½"
03-106-13	13 cm / 5"
03-106-14	14 cm / 5½"
03-106-15	15 cm / 6"
03-106-18	18 cm / 7"
03-106-20	20 cm / 8"



Deaver

03-108-14	14 cm / 5½"
03-109-14	



Mod. USA

03-184-10	10.5 cm / 4¼"
------------------	---------------

Scissors



Mayo
03-110-14 14 cm / 5½"
03-110-17 17 cm / 6¾"
 Straight
03-111-14 14 cm / 5½"
03-111-17 17 cm / 6¾"
 Curved



Mayo-Stille
03-114-15 15 cm / 6"
03-114-17 17 cm / 6¾"
 Straight
03-115-15 15 cm / 6"
03-115-17 17 cm / 6¾"
 Curved

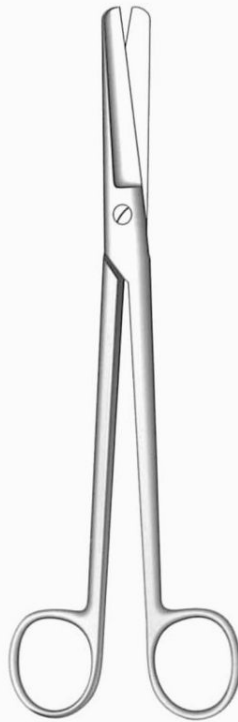

Sims
03-120-20 20 cm / 8"
03-120-23 23 cm / 9"
 Straight
03-121-20 20 cm / 8"
03-121-23 23 cm / 9"
 Curved

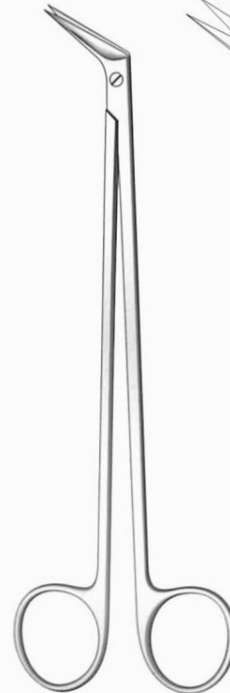

Potts Smith
 19 cm 7½"

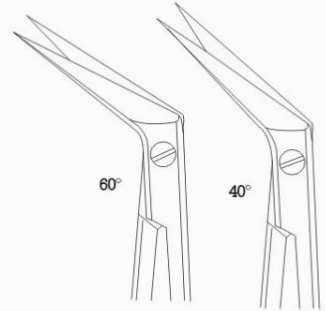

60°

40°

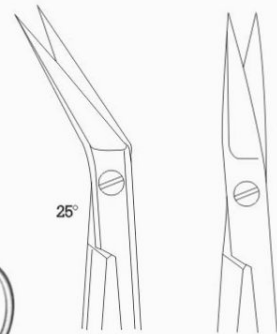

25°

03-168-19

03-169-19

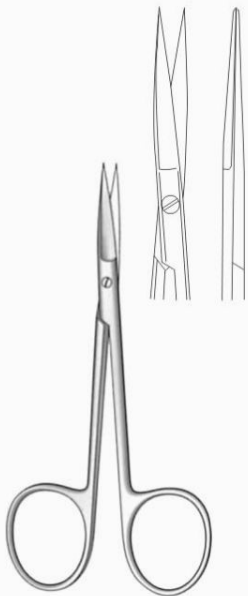

Iris
03-196-10 10.5 cm / 4¼"
03-200-11 11.5 cm / 4½"
 Straight
03-198-10 10.5 cm / 4¼"
03-201-11 11.5 cm / 4½"
 Curved



Strabismus
03-206-11 Straight
03-207-11 Curved
 11.5 cm / 4½"

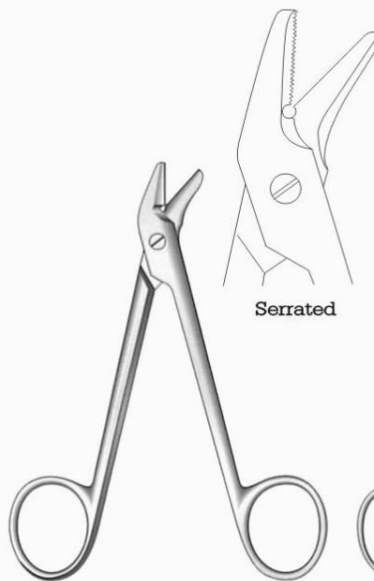

Serrated

Universal
03-215-12
 12 cm / 4¾"



Spencer
03-220-09 9 cm / 3½"
03-220-11 11 cm / 4¾"
03-220-13 13 cm / 5"

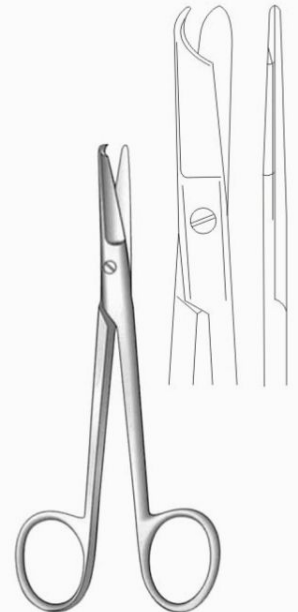

Lirrauer
03-223-14
 14 cm / 5½"

Artery Forceps

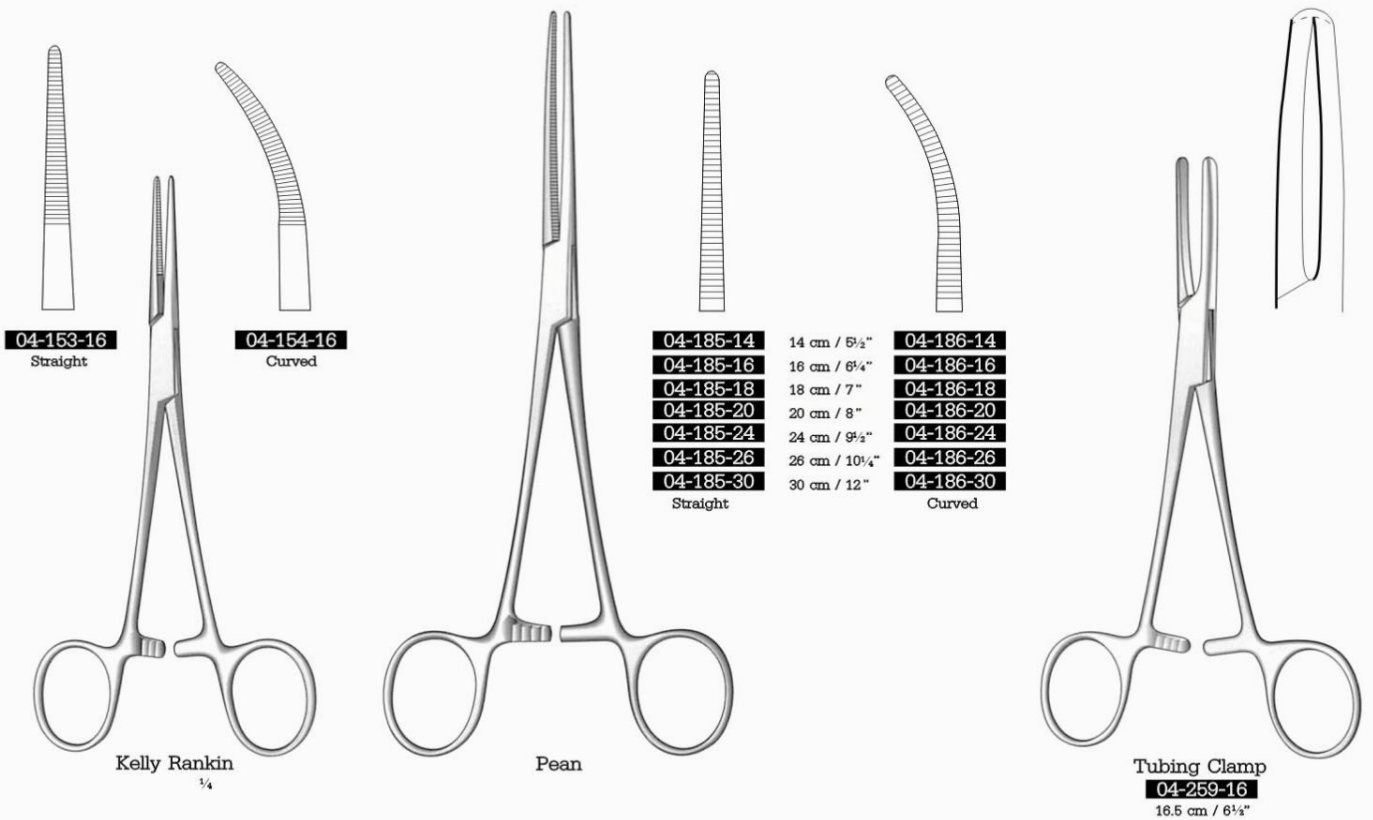
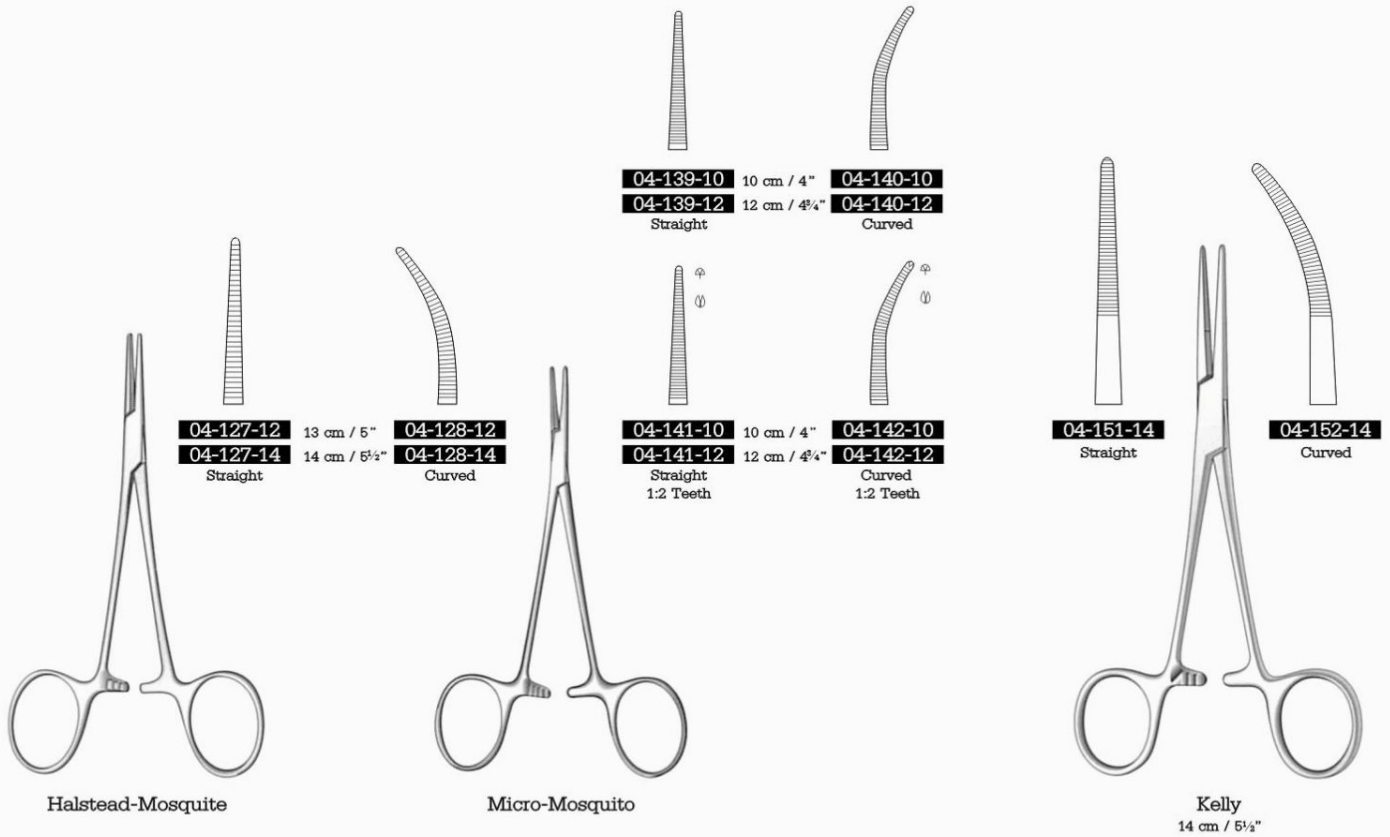

Artery Forceps

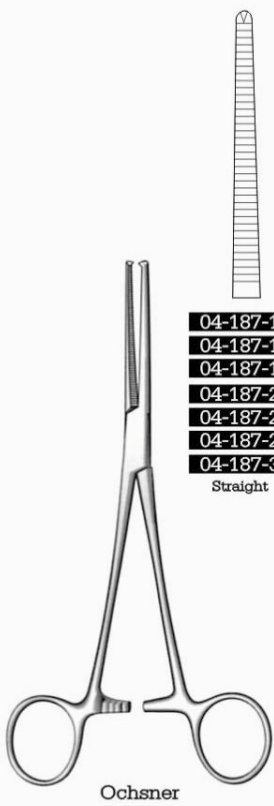

- | | | |
|------------------|--------------|------------------|
| 04-187-14 | 14 cm / 5½" | 04-188-14 |
| 04-187-16 | 16 cm / 6¼" | 04-188-16 |
| 04-187-18 | 18 cm / 7" | 04-188-18 |
| 04-187-20 | 20 cm / 8" | 04-188-20 |
| 04-187-24 | 24 cm / 9½" | 04-188-24 |
| 04-187-26 | 26 cm / 10¼" | 04-188-26 |
| 04-187-30 | 30 cm / 12" | 04-188-30 |
| Straight | | Curved |

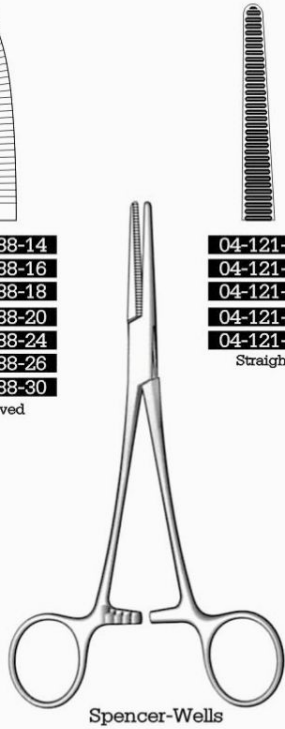

- | | | |
|------------------|-------------|------------------|
| 04-121-13 | 13 cm / 5" | 04-122-13 |
| 04-121-14 | 14 cm / 5½" | 04-122-14 |
| 04-121-15 | 15 cm / 6" | 04-122-15 |
| 04-121-18 | 18 cm / 7" | 04-122-18 |
| 04-121-20 | 20 cm / 8" | 04-122-20 |
| Straight | | Curved |



- | | | |
|------------------|-------------|------------------|
| 04-156-14 | 14 cm / 5½" | 04-157-14 |
| 04-156-16 | 16 cm / 6¼" | 04-157-16 |
| Straight | | Curved |

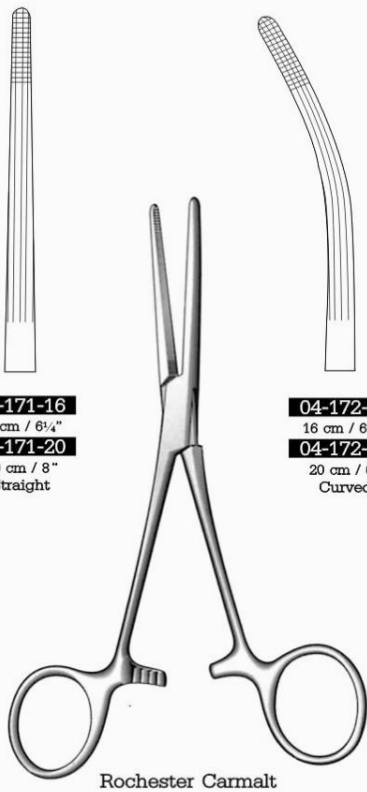

- | | | |
|------------------|-------------|------------------|
| 04-171-16 | 16 cm / 6¼" | 04-172-16 |
| 04-171-20 | 20 cm / 8" | 04-172-20 |
| Straight | | Curved |

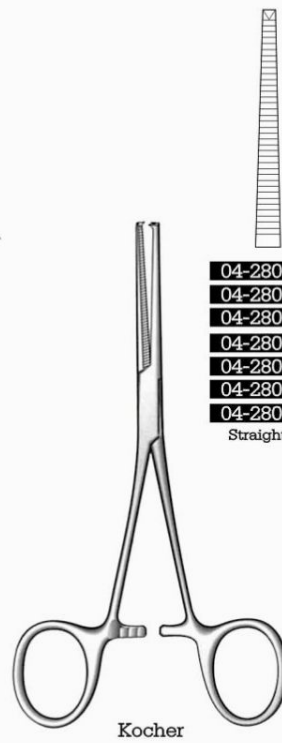

- | | | |
|------------------|--------------|------------------|
| 04-280-14 | 14 cm / 5½" | 04-281-14 |
| 04-280-16 | 16 cm / 6¼" | 04-281-16 |
| 04-280-18 | 18 cm / 7" | 04-281-18 |
| 04-280-20 | 20 cm / 8" | 04-281-20 |
| 04-280-24 | 24 cm / 9½" | 04-281-24 |
| 04-280-26 | 26 cm / 10¼" | 04-281-26 |
| 04-280-30 | 30 cm / 12" | 04-281-30 |
| Straight | | Curved |

Towel Clamps & Artery Forceps



Jones
04-248-05 5 cm / 2"
04-248-09 9 cm / 3 1/4"

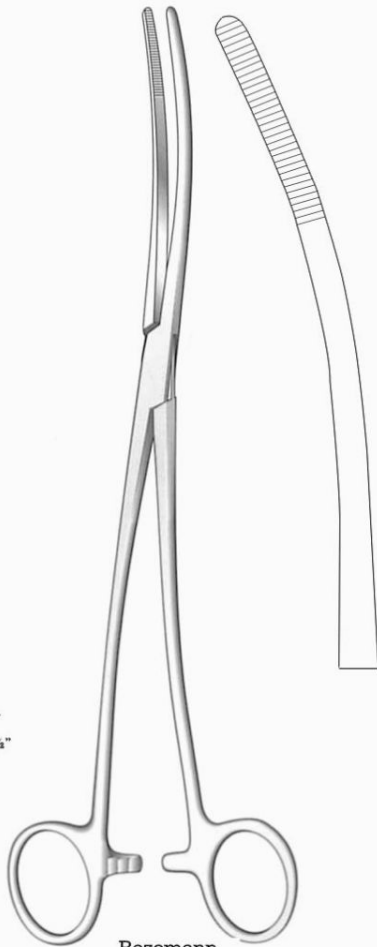

Bozemann
04-271-26
 26 cm / 10 1/4"

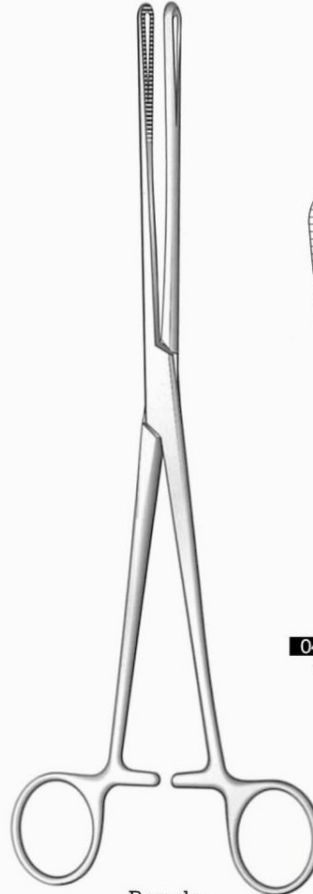

Rampley

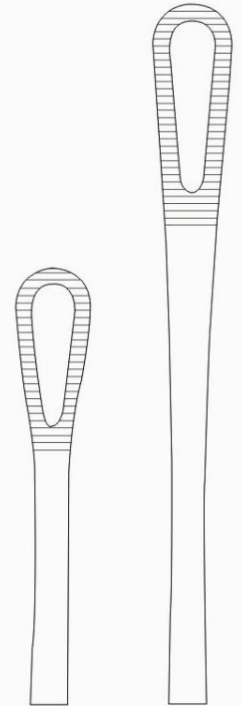

04-279-18
 18 cm / 7"

04-279-25
 25 cm / 10"



Schroeder
19-105-23 23 cm / 9"
19-105-25 25 cm / 10"

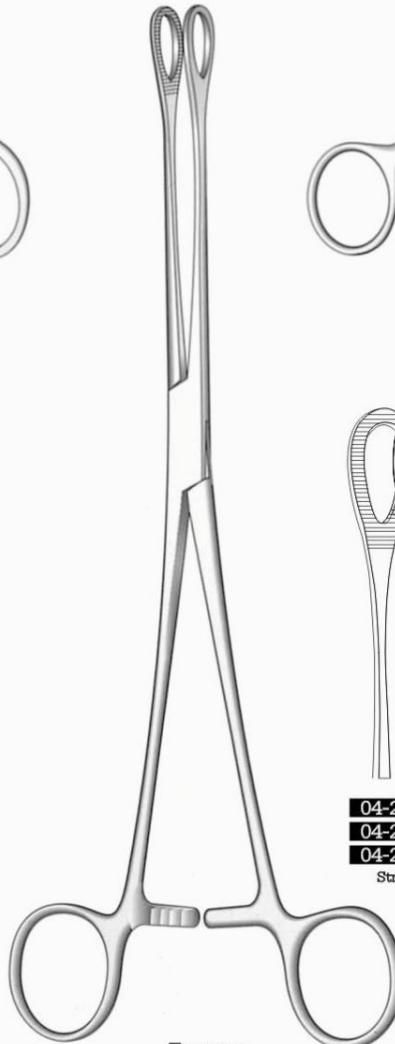

Foerster

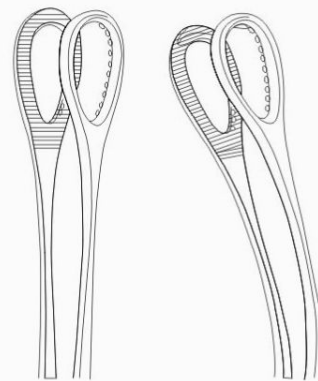

04-274-18 18 cm / 7"
04-274-20 20 cm / 8"
04-274-25 25 cm / 10"
 Straight

04-276-18
04-276-20
04-276-25
 Curved

Towel Clamps & Artery Forceps

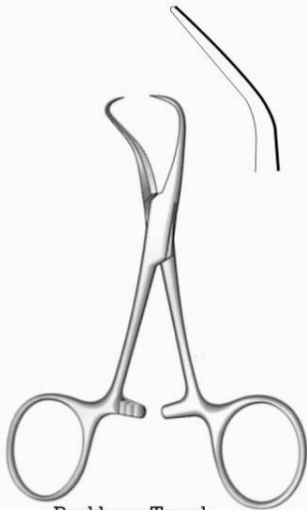

Backhaus Towel

- 04-251-08** 8 cm / 3¼"
- 04-251-11** 11.5 cm / 4¼"
- 04-251-13** 13 cm / 5¼"
- 04-251-15** 15 cm / 6"

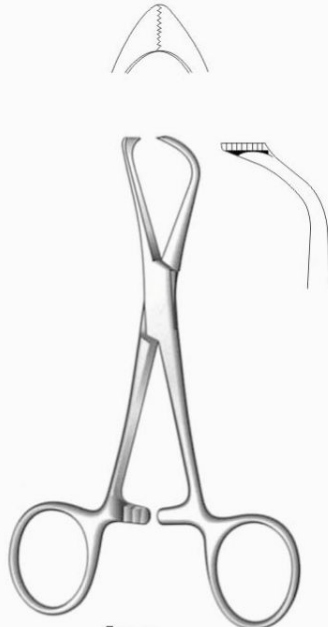

Loma

- 04-254-10** 10 cm / 4"
- 04-254-13** 13 cm / 5"

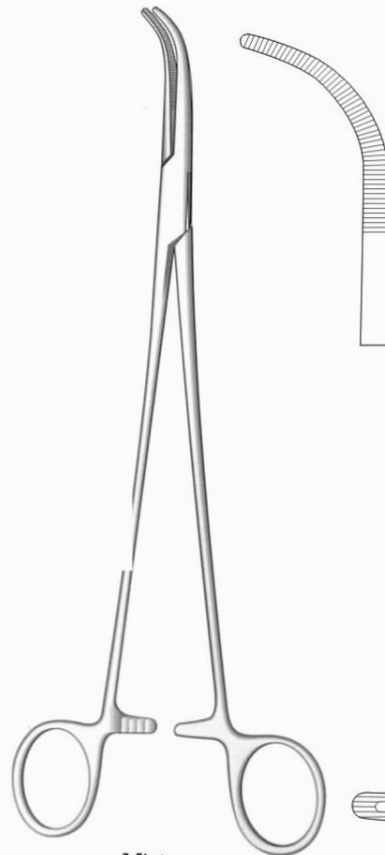

Mixer

- 04-211-23**
23 cm / 9"

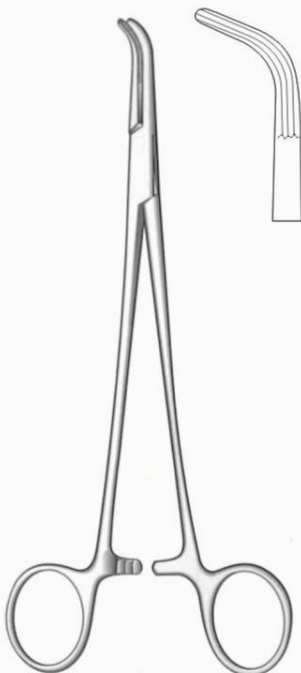

Lower

- 04-216-18**
18 cm / 7"

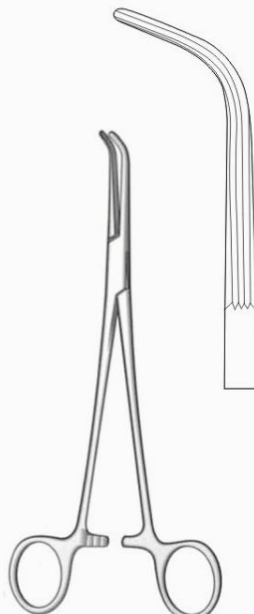

Lahey

- 04-217-19** 19 cm / 7½"
- 04-218-23** 23 cm / 9"

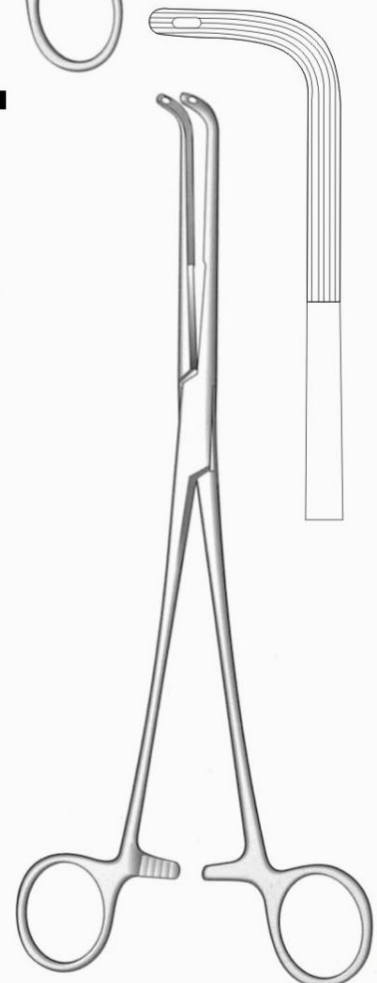

Finochietto

- 04-219-24**
24 cm / 9½"

Dressing & Tissue Forceps



Standard
05-101-11 11.5 cm / 4½"
05-101-13 13 cm / 5"
05-101-14 14 cm / 5½"
05-101-15 15 cm / 6"
05-101-18 18 cm / "
05-101-20 20 cm / 8"
05-101-25 25 cm / 10"
05-101-30 30 cm / 12"

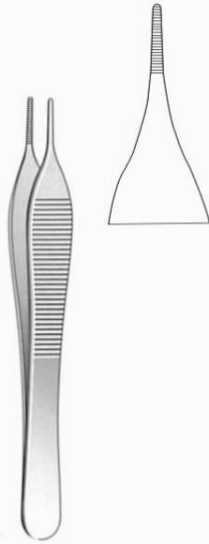

Adson
05-106-12 12 cm / 4¾"
05-106-15 15 cm / 6"



Tissue
05-118-11 11.5 cm / 4½"
05-118-13 13 cm / 5"
05-118-14 14 cm / 5½"
05-118-15 15 cm / 6"
05-118-18 18 cm / "
05-118-20 20 cm / 8"
05-118-25 25 cm / 10"
05-118-30 30 cm / 12"
 1:2 Teeth

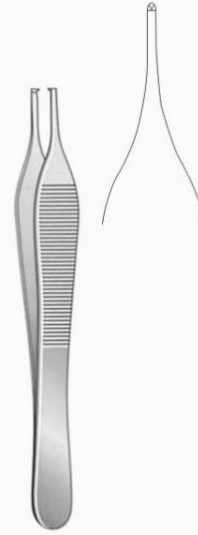

Adson Tissue
05-128-12 12 cm / 4¾"
05-129-15 15 cm / 6"

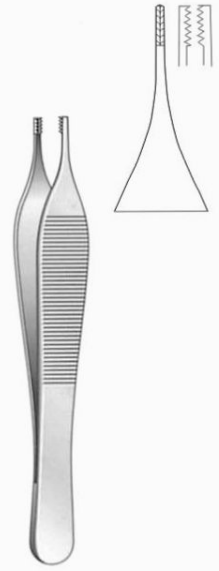

Adson-Brown
05-140-12 12 cm / 4¾"



Watchmaker
05-145-11
 No. 5



Watchmaker
05-145-12
 11 cm / 4¼"
 No. 7



Watchmaker
05-146-12
 11 cm / 4¼"
 No. 3



Feilchenfeld
05-159-09 9 cm / 3½"
05-159-11 11.5 cm / 4½"



Mc Indoe
05-107-15
 15 cm / 6"

Dressing & Tissue Forceps



Semken
05-110-13 13 cm / 5"
05-110-15 15 cm / 6"



Gillies
05-130-15 15 cm / 6"
1:2 Teeth



Semken
05-131-13 13 cm / 5"
05-131-15 15 cm / 6"
1:2 Teeth



Bonney
05-150-18 18 cm / 7"



Splinter
05-156-11 11.5 cm / 4"

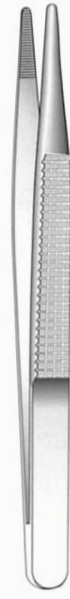

Bonney
15-174-18 18 cm / 7"



Lane
05-177-14 14 cm / 5½"
05-178-18 18 cm / 7"



T.O.E Forceps
05-175-13 13 cm / 5"



Russ. Model
05-148-15 15 cm / 6"
05-148-20 20 cm / 8"
05-148-25 25 cm / 10"



Cushing
05-138-17 17 cm / 6¾"



Treve Forceps
05-156-13 13 cm / 5"
05-176-14 14 cm / 5½"



Treve Tissue Forceps
05-177-13 13 cm / 5"
05-177-14 14 cm / 5½"
1:2 Teeth

Retractors

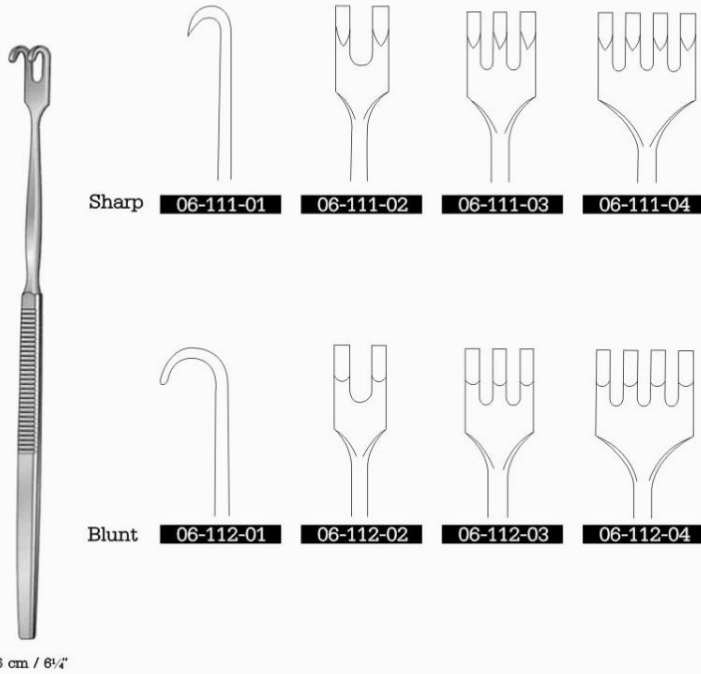

Gelpi-Loktire

- 06-241-14 14 cm / 5 1/2"
- 06-242-18 18 cm / 7 "

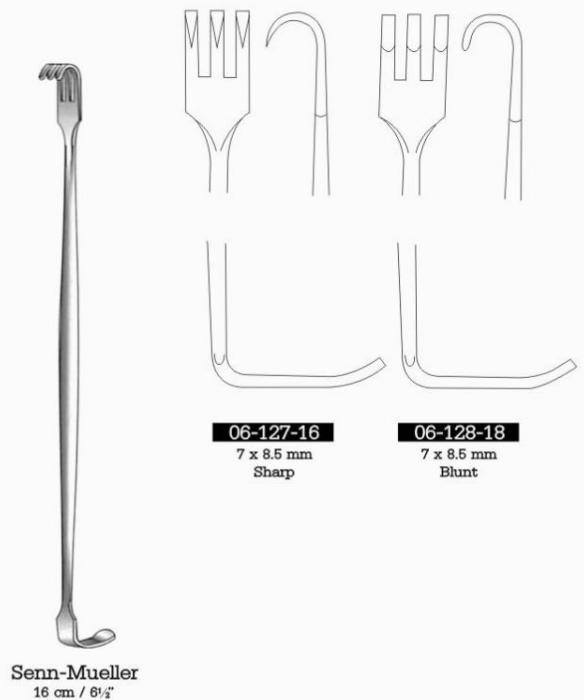

Retractors

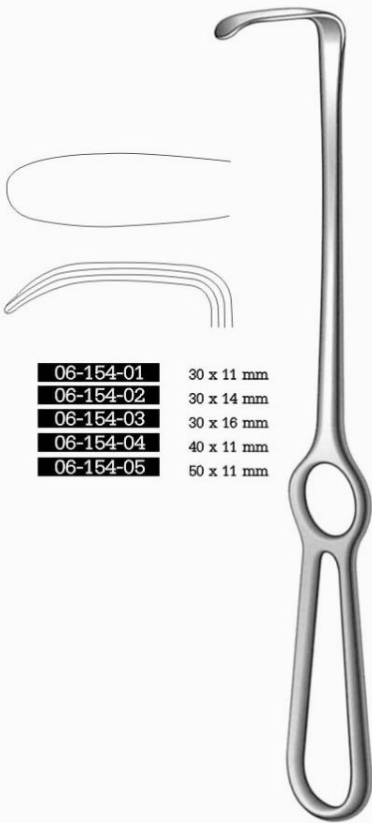

- 06-154-01** 30 x 11 mm
- 06-154-02** 30 x 14 mm
- 06-154-03** 30 x 16 mm
- 06-154-04** 40 x 11 mm
- 06-154-05** 50 x 11 mm

Langenbeck
22 cm / 8½"

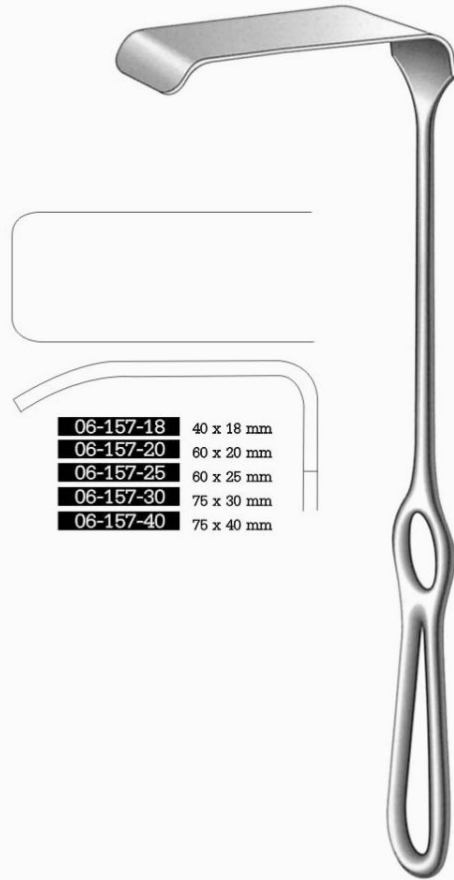

- 06-157-18** 40 x 18 mm
- 06-157-20** 60 x 20 mm
- 06-157-25** 60 x 25 mm
- 06-157-30** 75 x 30 mm
- 06-157-40** 75 x 40 mm

Kocher
23 cm / 9"



Farabeuf
06-193-12 12 cm
06-194-15 15 cm
Set of 2



U.S. Army
06-200-00
21 cm / 8¼"
Set of 2

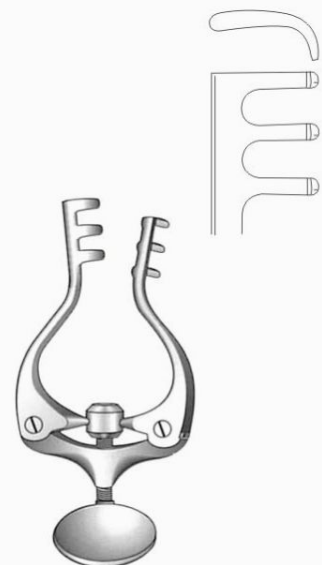

Jansen
06-206-10
10 cm / 4"
3:3 teeth
Blunt

Retractors



Richardson-Eastmann

- 06-164-00** Set of 2
- 06-164-01** Fig. 1, 26 cm / 10¼"
- 06-164-02** Fig. 2, 28 cm / 11"



06-221-13
13 cm / 5"
3:4 teeth, Sharp

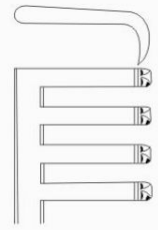

06-221-16
16.5 cm / 6½"
3:4 teeth, Sharp

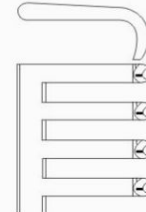

06-222-13
13 cm / 5"
3:4 teeth, Blunt

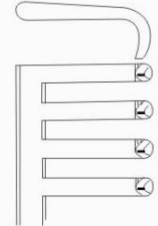

06-222-16
16.5 cm / 6½"
3:4 teeth, Blunt



Mollison
06-223-15
15 cm / 6"
Sharp

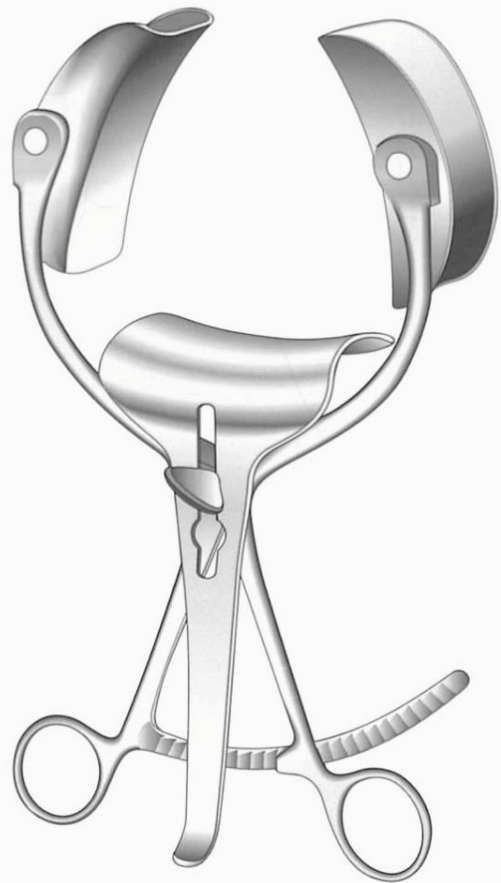
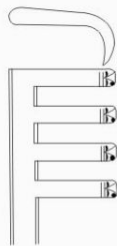

Collin	Lateral Blades	Central Blade
06-246-00	38 x 60 mm	38 x 55 mm
06-247-00	38 x 60 mm	50 x 75 mm

Probes



Probe D/End
07-101-13 13 cm / 5"
07-101-14 14 cm / 5½"
07-101-16 16 cm / 6¼"
07-101-18 18 cm / 7"
07-101-20 20 cm / 8"
 2 mm Ø



Silver Probe
07-119-13
 13 cm / 5"



Probe With Eye
07-103-13 13 cm / 5"
07-103-14 14 cm / 5½"
07-103-16 16 cm / 6¼"
07-103-18 18 cm / 7"
 2 mm Ø



Jobson Probe
07-118-13 13 cm / 5"
07-118-18 18 cm / 7"



Butterfly
07-106-13 13 cm / 5"
07-106-14 14 cm / 5½"
07-106-16 16 cm / 6¼"



Butterfly With Probe
07-107-13 13 cm / 5"
07-107-14 14 cm / 5½"
07-107-16 16 cm / 6¼"

Anaesthesia

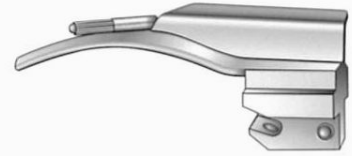
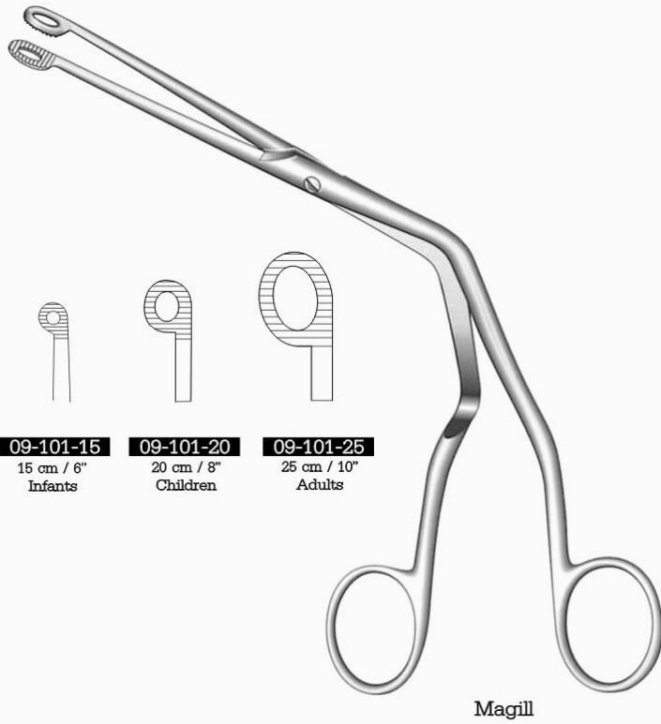

09-106-00
Fig. 00



09-106-01
Fig. 01



09-106-02
Fig. 02



09-106-03
Fig. 3



09-106-04
Fig. 4



McIntosh
09-105-00
Complete Set

Laryngoscope Set

Consisting of:

- 09-105-01 Battery Handle (without batteries)
- 09-106-00 McIntosh Blade, Fig. 00
- 09-106-01 McIntosh Blade, Fig. 01
- 09-106-02 McIntosh Blade, Fig. 02
- 09-106-03 McIntosh Blade, Fig. 03
- 09-106-04 McIntosh Blade, Fig. 04
- 09-106-05 Case only

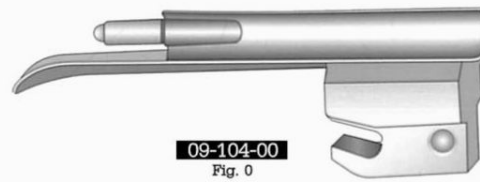
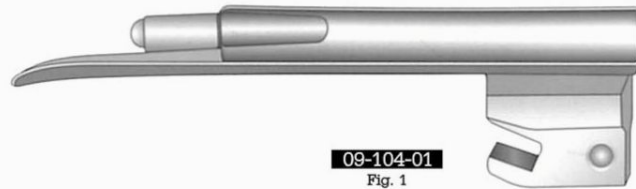

Miller

09-103-00
Complete Set

Laryngoscope Set

Consisting of:

- 09-103-01** Battery Handle (without batteries)
- 09-104-00** Miller Blade Fig. 0
- 09-104-01** Miller Blade Fig. 1
- 09-104-02** Miller Blade Fig. 2
- 09-104-03** Miller Blade Fig. 3
- 09-104-04** Miller Blade Fig. 4
- 09-104-05** Case only

Anaesthesia



09-110-01
Fig. 01



09-110-02
Fig. 02



09-110-03
Fig. 03



09-110-04
Fig. 04

Mcintosh

09-109-00

Fiber Optic Laryngoscope Set with 4 blades
(Fig. 01 to Fig. 04) in wooden / rexin box.

09-109-01 Handle only (without batteries)

09-110-01 Blade Fig. 01

09-110-02 Blade Fig. 02

09-110-03 Blade Fig. 03

09-110-04 Blade Fig. 04

09-110-05 Case only

Suture

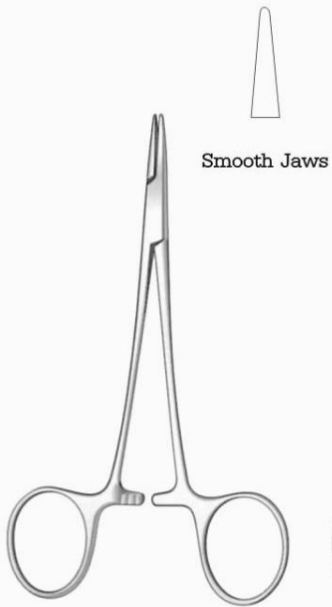

Smooth Jaws

Webster
10-101-13
13 cm / 5"



Hegar-Baumgartner
10-106-14
14 cm / 5½"



Crile-wood
10-109-15
15 cm / 6"

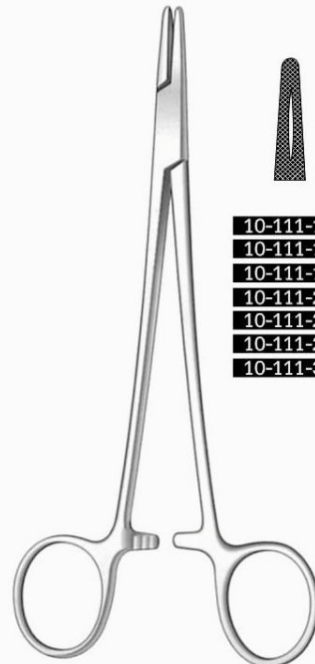

- 10-111-14 14 cm / 5½"
- 10-111-16 16 cm / 6¼"
- 10-111-18 18 cm / 7"
- 10-111-20 20 cm / 8"
- 10-111-24 24 cm / 9½"
- 10-111-26 26 cm / 10¼"
- 10-111-30 30 cm / 12"

Mayo-Hegar

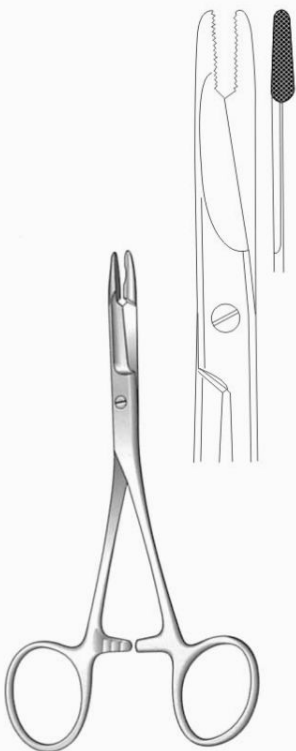

Olsen-Hegar
10-119-14
14 cm / 5½"

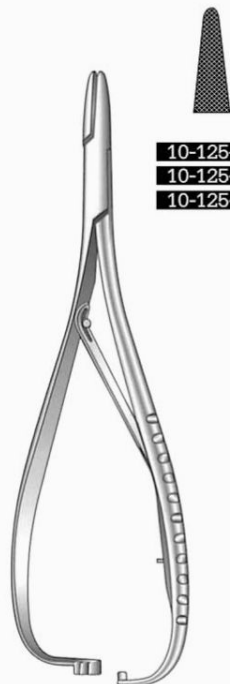

- 10-125-14 14 cm / 5½"
- 10-125-17 17 cm / 6¾"
- 10-125-20 20 cm / 8"

Mathieu



Michel
10-177-12
12 cm / 4¾"

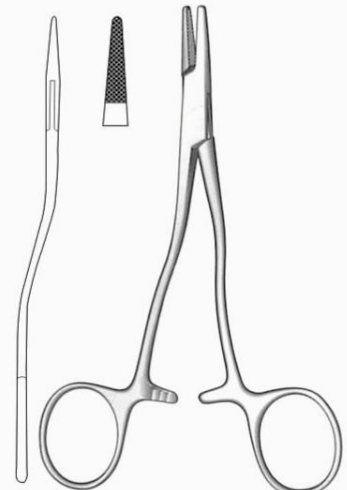

Kilner
10-185-14
14 cm / 5½"

Dressing - Bandage Scissors & Plastic Shears

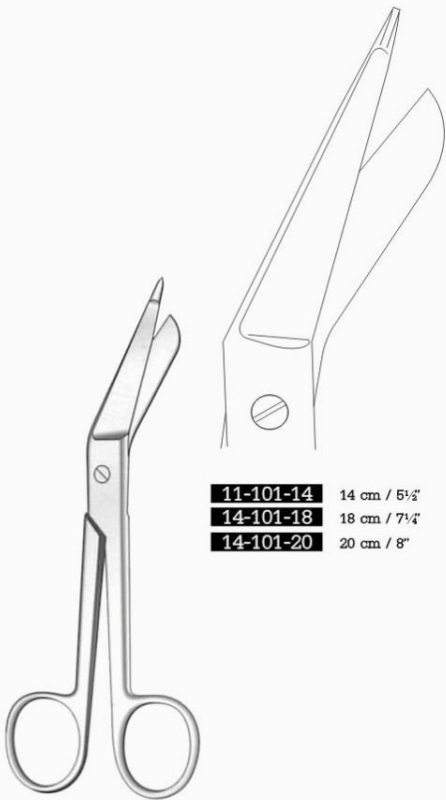

11-101-14 14 cm / 5½"
14-101-18 18 cm / 7¼"
14-101-20 20 cm / 8"

Lister Bandage Scissor



Tough Cut
11-102-15 15 cm / 6"
14-102-18 18 cm / 7¼"
 Different Colours



Bergmann
11-103-23
 23 cm / 9"

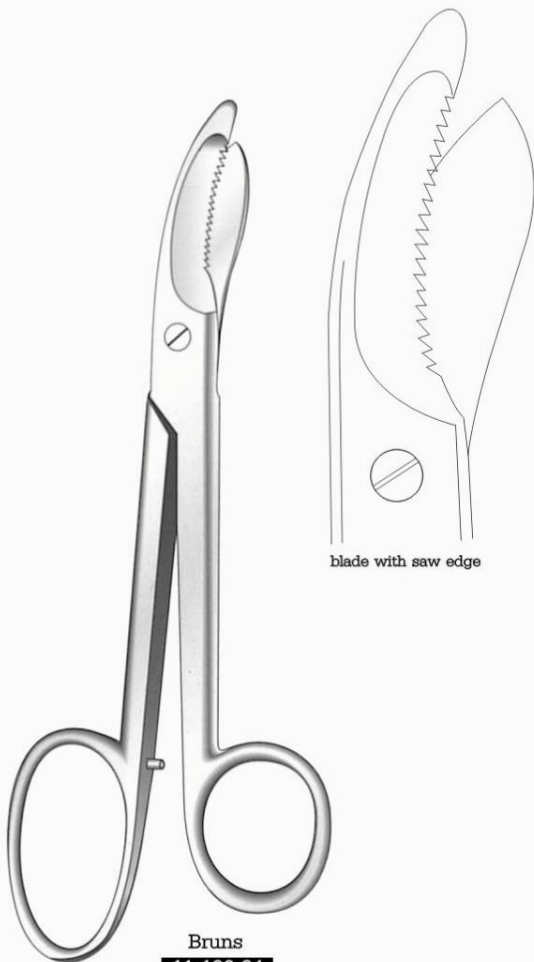

blade with saw edge

Bruns
11-106-24
 24 cm / 9½"

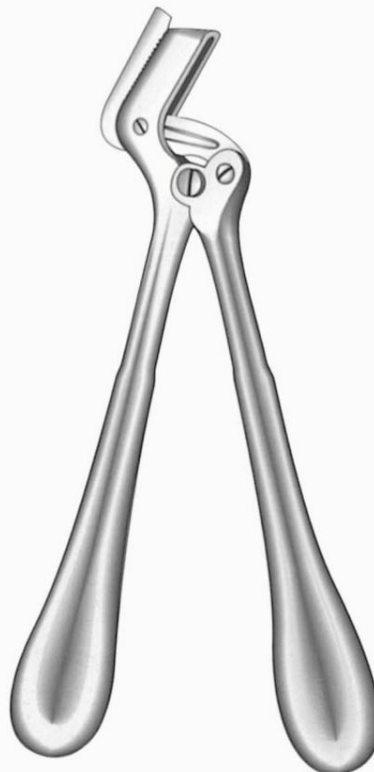

Stille
11-106-26 26 cm / 10¼"
11-106-37 37 cm / 14½"

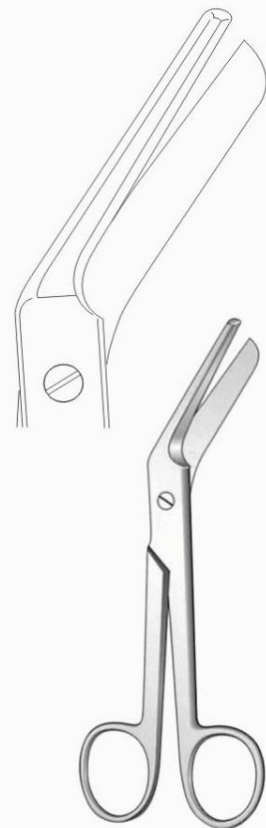

Braun-Stadler
03-180-14 14 cm / 5½"
03-181-22 22 cm / 8¼"

Bone Surgery



Hudson
12-111-00
27 cm / 10½"



12-111-01
9 mm Ø



12-111-02
14 mm Ø



12-111-03
16 mm Ø



12-111-04
22 mm Ø



12-111-05
14 mm Ø



12-111-06
13 mm Ø



12-111-07
16 mm Ø



Charriere
12-103-27
27cm / 10½"



Satterlee
12-104-29
29 cm / 11½"
Length of blade = 20 cm / 8"
12-104-20
Spare saw blade



Gerster-Lowman
12-123-18 18 cm / 7"
12-123-20 20 cm / 8"
12-123-22 22 cm / 8¾"



12-133-15
15 cm / 6"

Bone Surgery

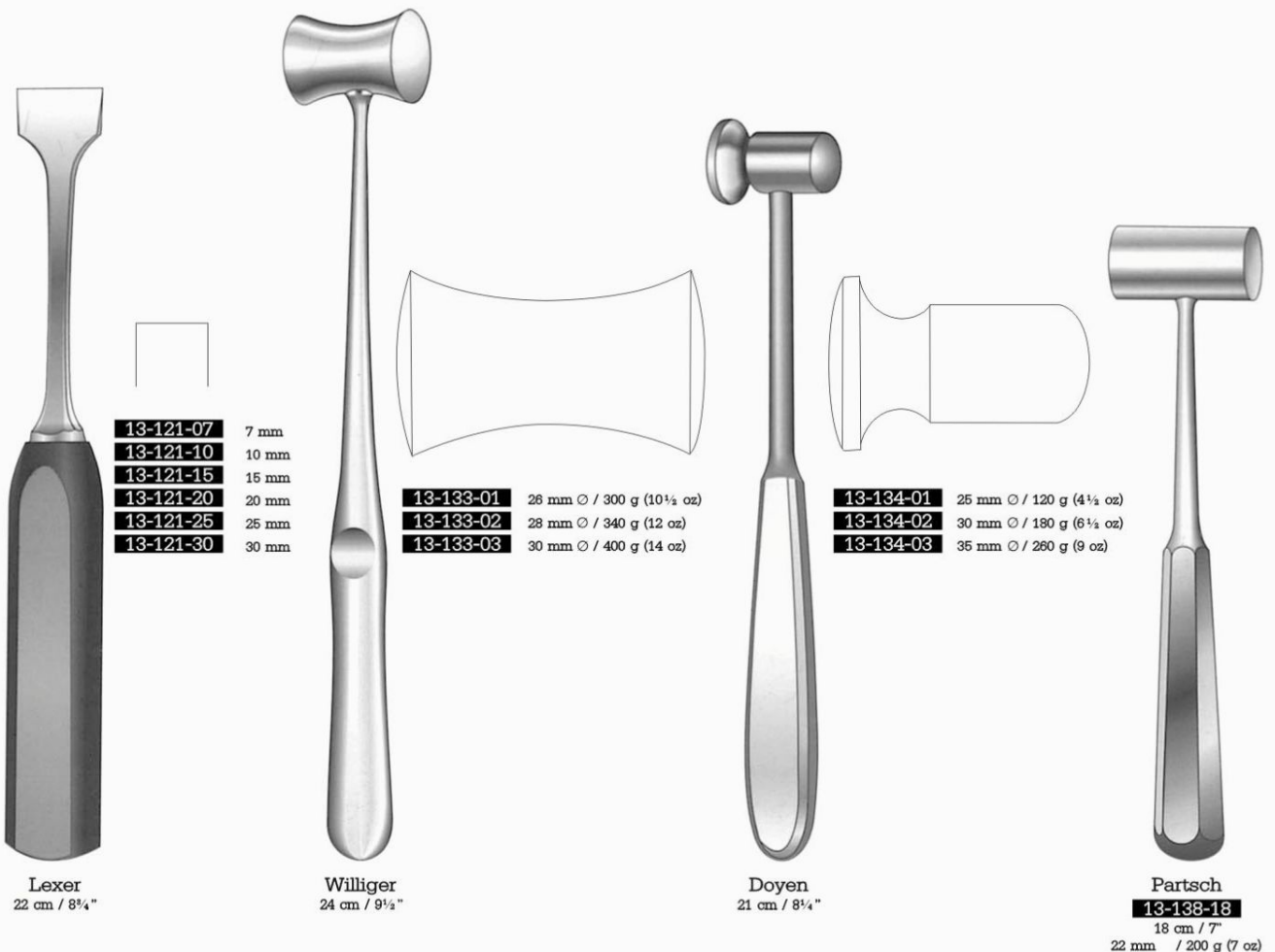
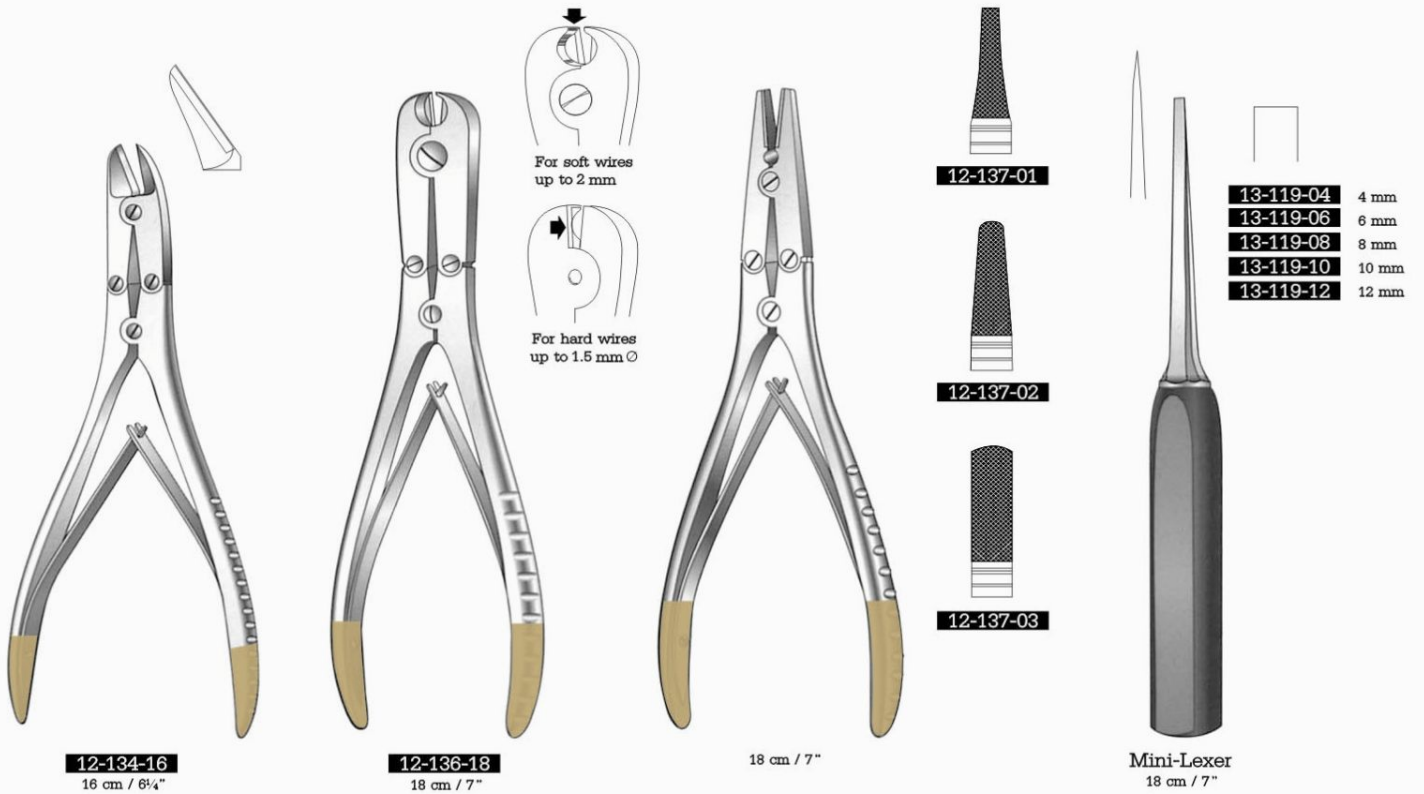

Bone Surgery

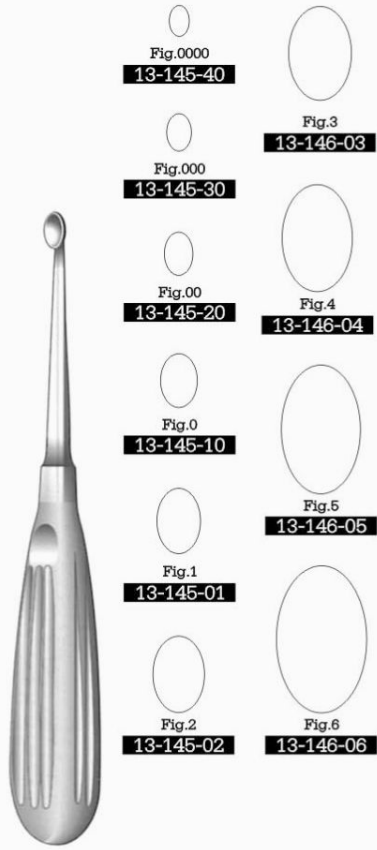

Volkman
17 cm / 6¾"



Hohmann
13-215-43
43 mm



Kern
13-243-17 17 cm / 6¾"
13-243-21 21 cm / 8¼"

Bennett
43 mm
60 mm
24 cm / 9½"

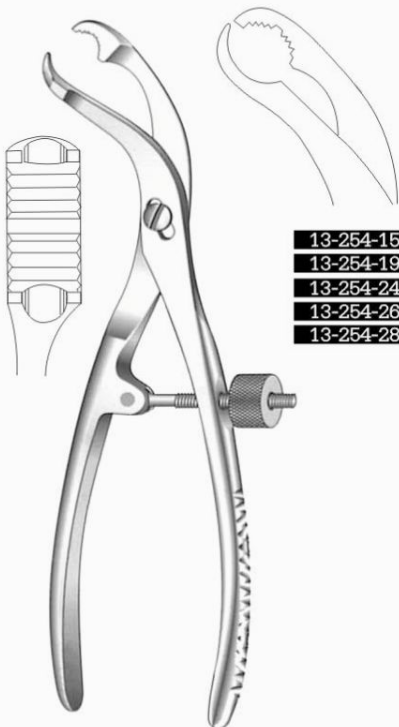

13-254-15 15 cm / 6", 2.5 mm
13-254-19 19 cm / 7½", 6.5 mm
13-254-24 24 cm / 9½", 9.5 mm
13-254-26 26 cm / 10¼", 10 mm
13-254-28 28 cm / 11", 11 mm

Self-Centering Forceps
with thread fixation

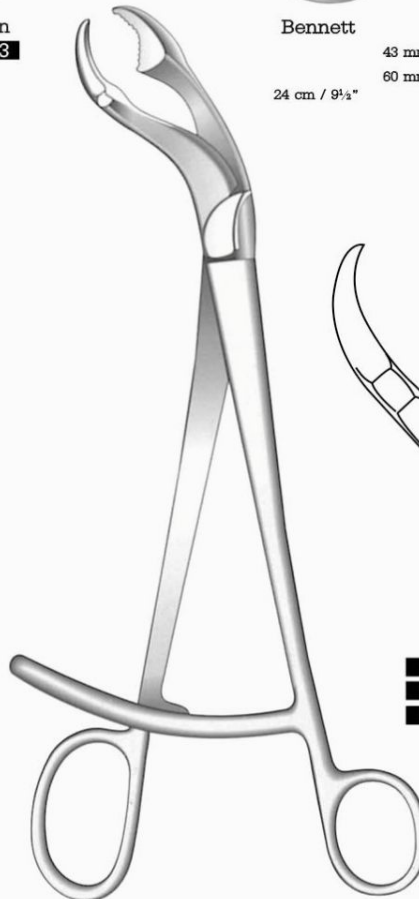

13-255-01 25 cm / 10", 9.5 mm
13-255-02 26 cm / 10½", 10.5 mm
13-255-03 27 cm / 11", 12 mm

Verbrugge

Bone Surgery

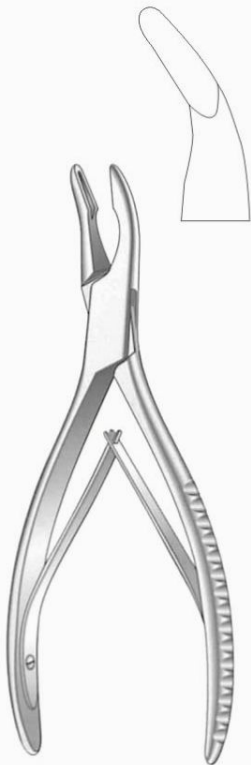

Mead
13-264-16
16.5 cm / 6½"

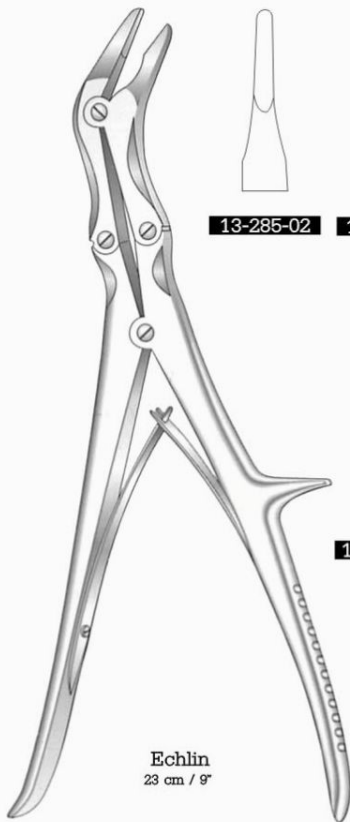

Echlin
23 cm / 9"

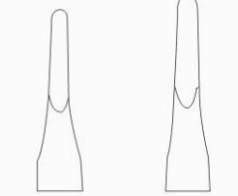

13-285-02 **13-285-03**



13-285-04



Luer
15 cm / 6"



13-273-15

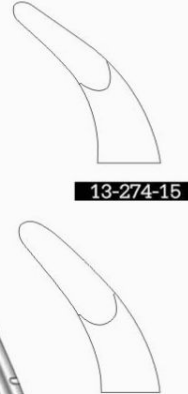

13-274-15

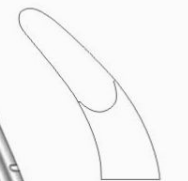

13-275-15

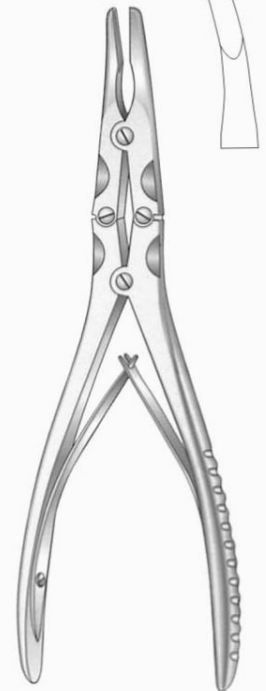

Bayer
13-278-18
18 cm / 7"

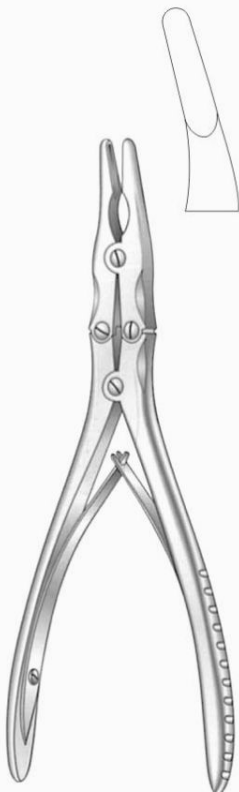

Zaufal-Jansen
13-279-18
18 cm / 7"

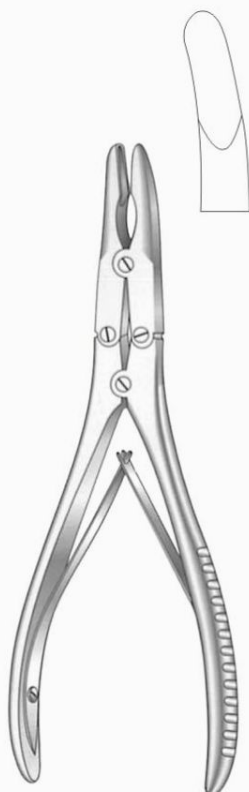

Ruskin
13-282-18 18 cm / 7"
13-282-23 23 cm / 9"

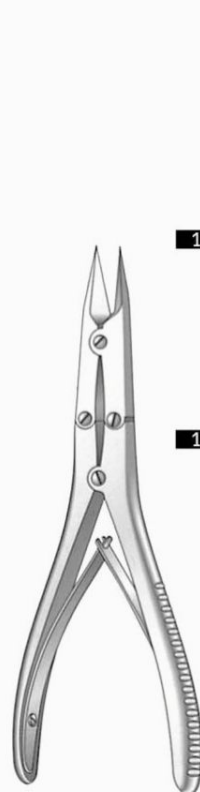

15 cm / 6"



13-298-15



13-299-15



Liston



13-294-14
14 cm / 5½"



13-294-17
17 cm / 6¾"



13-294-19
19 cm / 7½"



13-294-22
22 cm / 8¾"

Bone Surgery

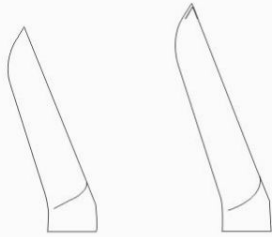

13-195-14
14 cm / 5½"

13-295-17
17 cm / 6¾"

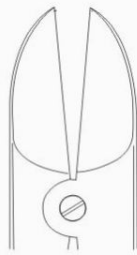

13-300-18
Straight



13-301-18
Angled



13-308-23
23 cm / 9"
13-308-27
27 cm / 10½"

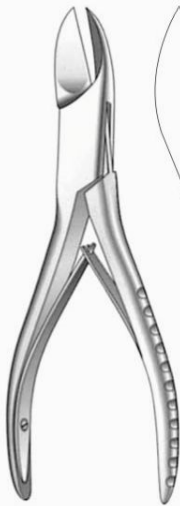

Liston

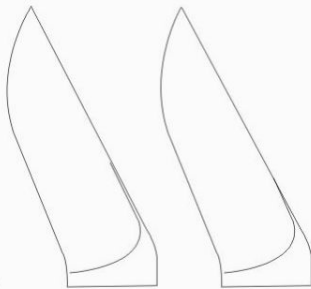

13-295-19
19 cm / 7½"

13-295-22
22 cm / 8¾"

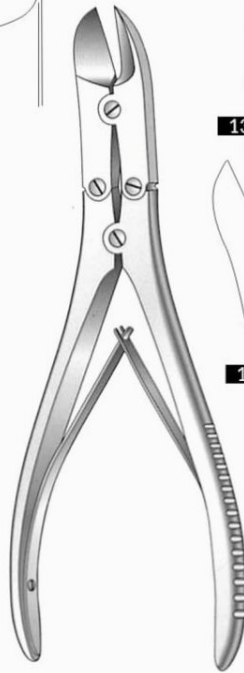

Ruskin
18.5 cm / 7¼"

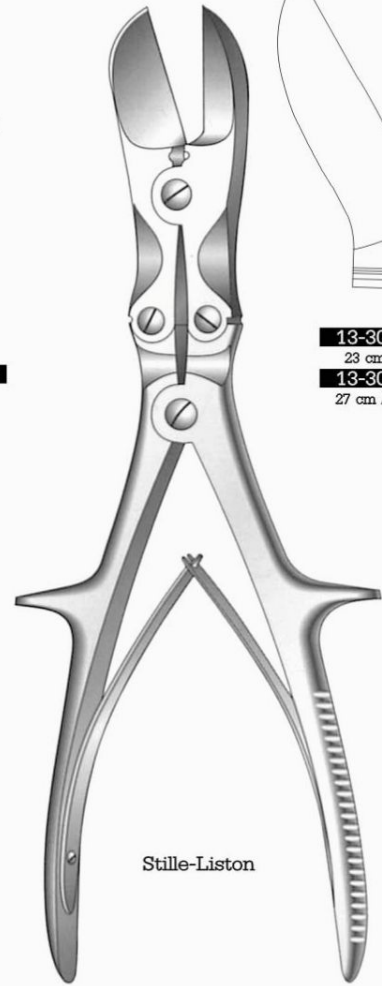

Stille-Liston

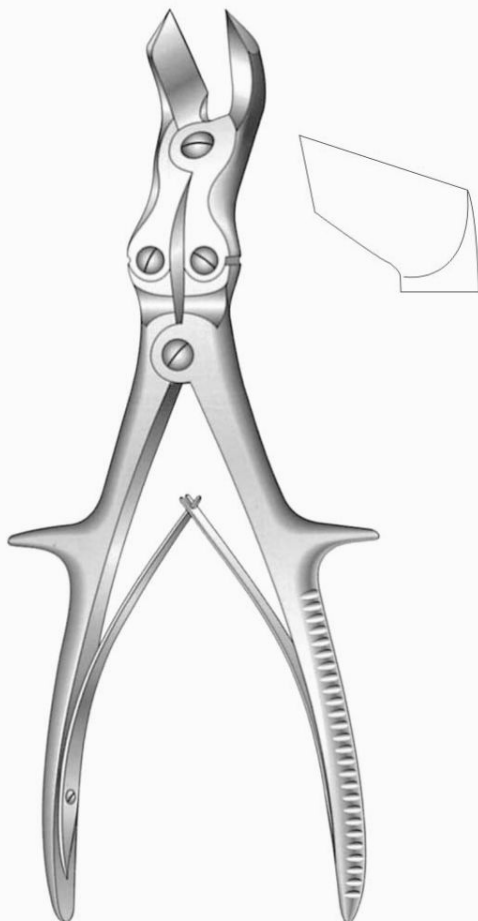

Liston-Key
13-310-27
27 cm / 10½"



Plier Action
13-313-17 17 cm / 6¾"
13-314-01 Spare blade

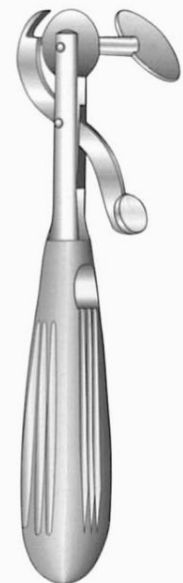

Thumb Action
13-315-16 16 cm / 6¼"
13-316-01 Spare blade

Cardiovascular Surgery

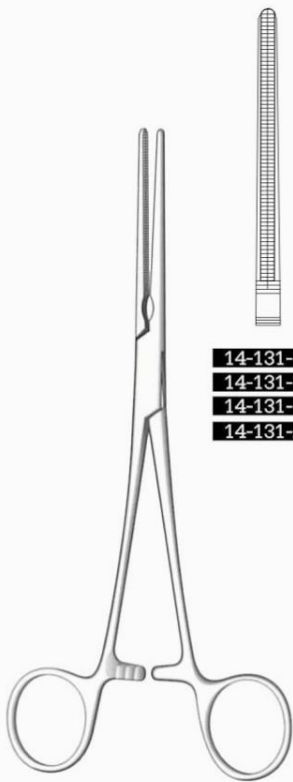

De Bakey-Pean

- | | | |
|------------------|-------------|------------------|
| 14-131-14 | 14 cm / 5½" | 14-132-14 |
| 14-131-16 | 16 cm / 6¼" | 14-132-16 |
| 14-131-18 | 18 cm / 7" | 14-132-18 |
| 14-131-20 | 20 cm / 8" | 14-132-20 |

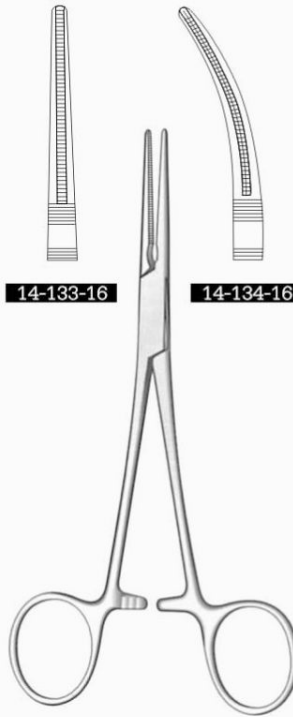

De Bakey-Rankin
16 cm / 6¼"

- | | |
|------------------|------------------|
| 14-133-16 | 14-134-16 |
|------------------|------------------|

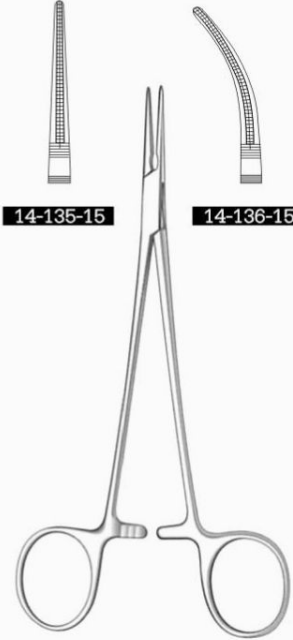

DeBakey-Mosquito
15 cm / 6"

- | | |
|------------------|------------------|
| 14-135-15 | 14-136-15 |
|------------------|------------------|

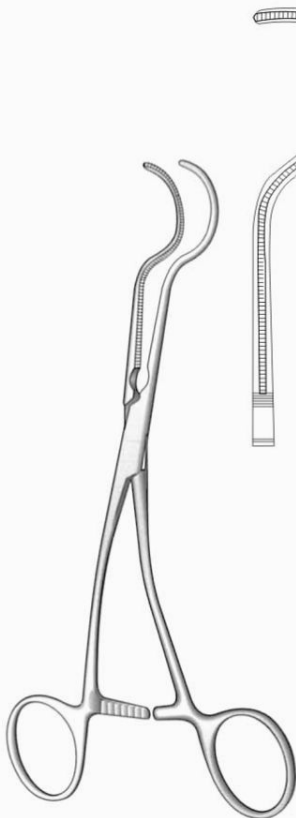

Dale

- | | |
|------------------|-------------|
| 14-140-17 | 17 cm / 6¾" |
| 14-140-18 | 18 cm / 7" |
| 14-140-19 | 19 cm / 7½" |

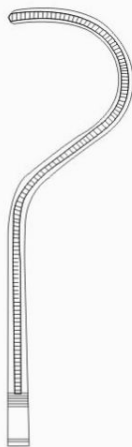

Cooley

- | | |
|------------------|-------------|
| 14-146-16 | 16 cm / 6¼" |
| 14-146-20 | 20 cm / 8" |

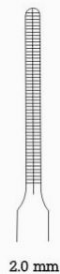

De Bakey

- | | |
|------------------|-------------|
| 14-147-16 | 16 cm / 6¼" |
| 14-147-20 | 20 cm / 8" |
| 14-147-24 | 24 cm / 9½" |
| 14-147-30 | 30 cm / 12" |



De Bakey

- | | |
|------------------|-------------|
| 14-150-16 | 16 cm / 6¼" |
| 14-150-20 | 20 cm / 8" |
| 14-150-24 | 24 cm / 9½" |
| 14-150-30 | 30 cm / 12" |

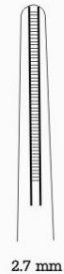

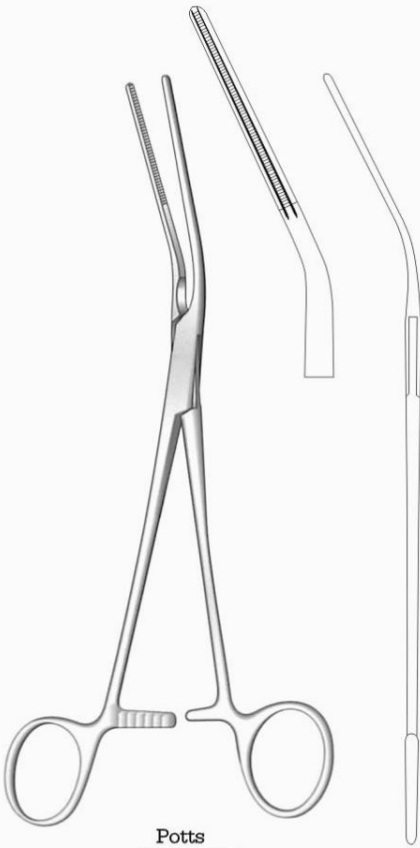

Potts
14-160-21 21 cm / 8¹/₄"
14-160-22 22 cm / 8³/₄"



Bainbridge
14-163-15 15 cm / 6"
14-163-18 18 cm / 7"

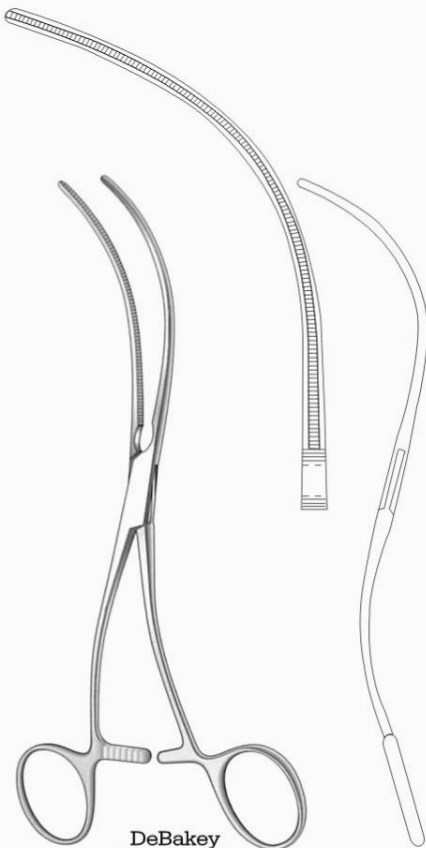

DeBaakey
14-163-19 19 cm / 7¹/₂"
14-163-20 20 cm / 8"



Satinsky
14-166-20 20 cm / 8"
14-166-24 24 cm / 7¹/₂"
14-166-25 25 cm / 10"
14-166-26 26.5 cm / 10¹/₂"



DeBaakey
14-169-17 17 cm / 6³/₄"

Intestine



Judd-Allis
17-101-15 15 cm / 6"
17-101-19 19 cm / 7½"
 3:4 Teeth

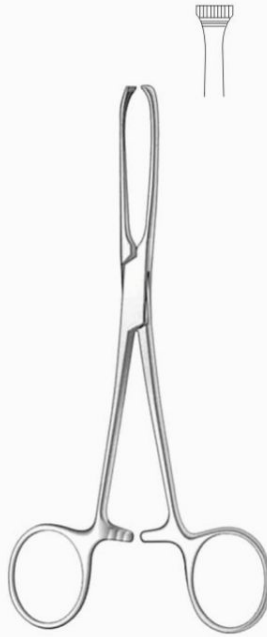

Allis-Tissue
17-105-15 15 cm / 6"
17-105-19 19 cm / 7½"
17-105-55 25 cm / 10"
17-105-30 30 cm / 12"
 5:6 Teeth

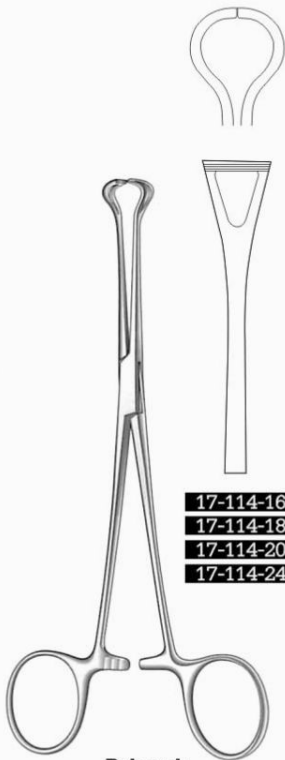
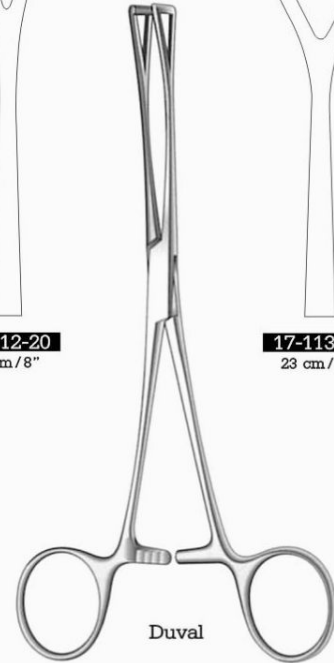
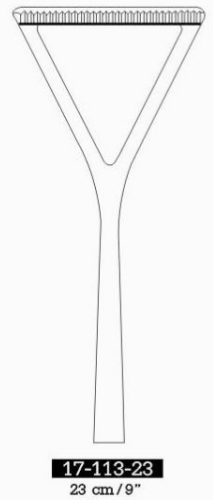
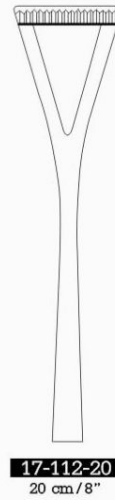

17-114-16 16 cm / 6¼"
17-114-18 18 cm / 7"
17-114-20 20 cm / 8"
17-114-24 24 cm / 9½"

Babcock

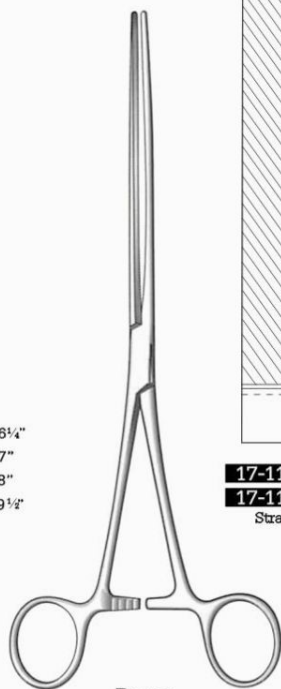

17-117-21 21 cm / 8¼"
17-117-23 23 cm / 9"
 Straight

Doyen

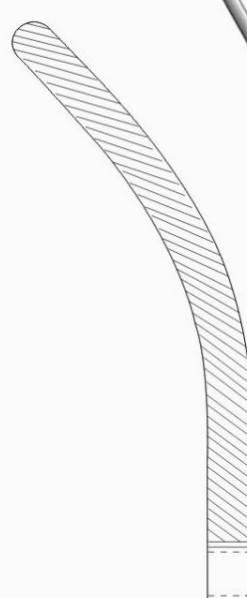

17-118-21
17-118-23
 Curved

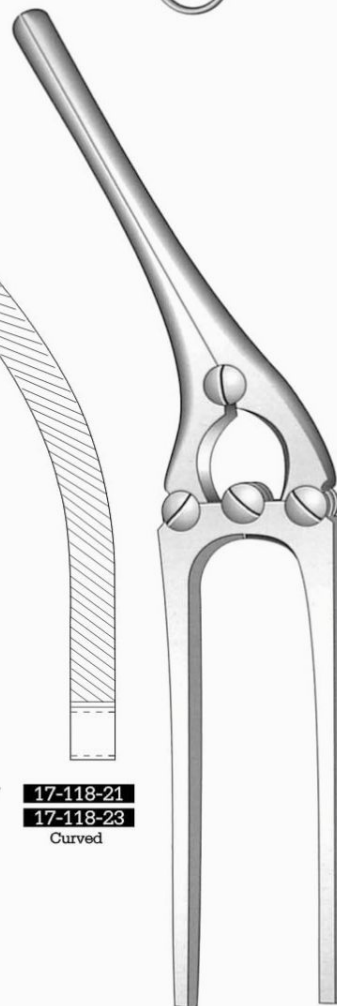

Payr
17-131-20 20 cm / 8"
17-132-27 27.5 cm / 10¾"
17-132-31 31.5 cm / 12½"
 With pin

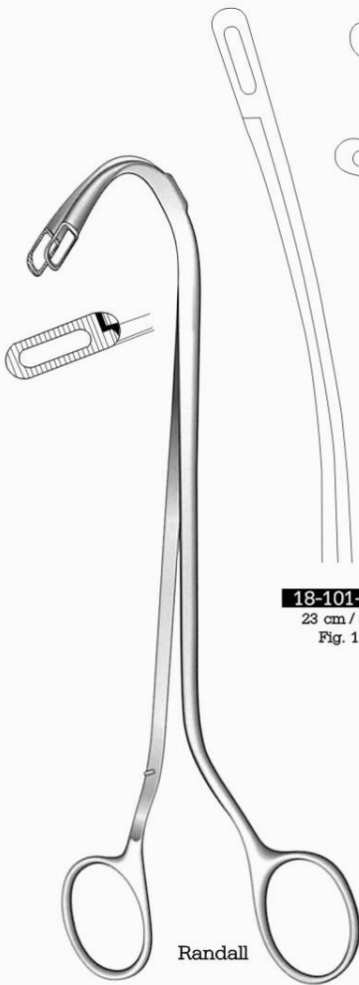

18-101-23
23 cm / 9"
Fig. 1

Randall



18-103-22
22 cm / 8½"
Fig. 3

18-102-22
22 cm / 8½"
Fig. 2

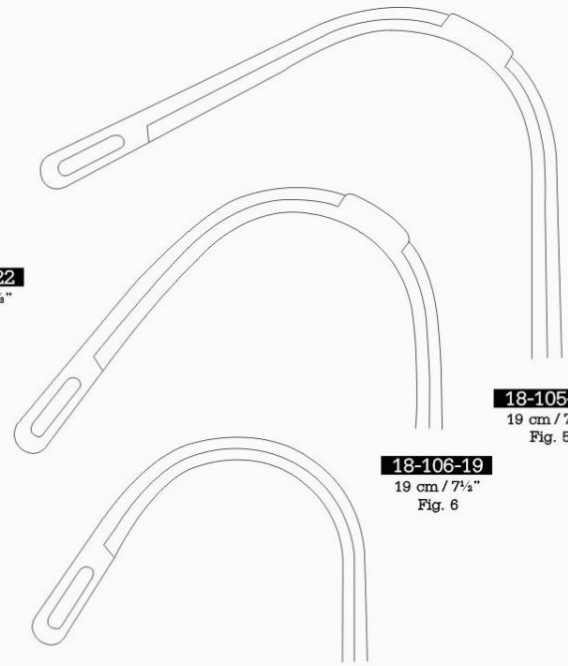

18-105-19
19 cm / 7½"
Fig. 5

18-106-19
19 cm / 7½"
Fig. 6

18-104-22
22 cm / 8½"
Fig. 4

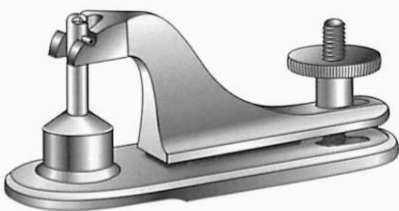

Circumcision Clamp

- 18-137-08** 8 mm Ø, baby size
- 18-137-11** 11 mm Ø, child size
- 18-137-13** 13 mm Ø, child size
- 18-137-16** 16 mm Ø, adult size
- 18-137-21** 21 mm Ø, adult size
- 18-137-26** 26 mm Ø, men's size
- 18-137-32** 32 mm Ø, men's size

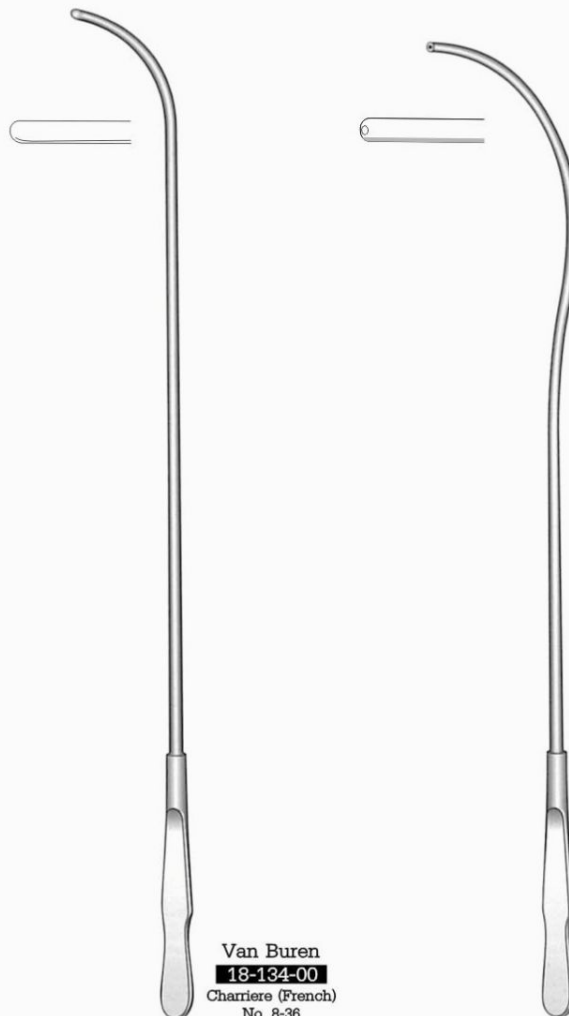

Van Buren
18-134-00
Charriere (French)
No. 8-36

Guyon
18-135-00
Charriere (French)
No. 10-30

Gynecology



Cusco
19-164-01 75 x 32 mm
19-164-02 85 x 35 mm
19-164-03 100 x 37 mm
 Centre Screw



Cusco
19-167-01 75 x 32 mm
19-167-02 85 x 35 mm
19-167-03 100 x 35 mm
 Side Screw



Winterton
19-168-00

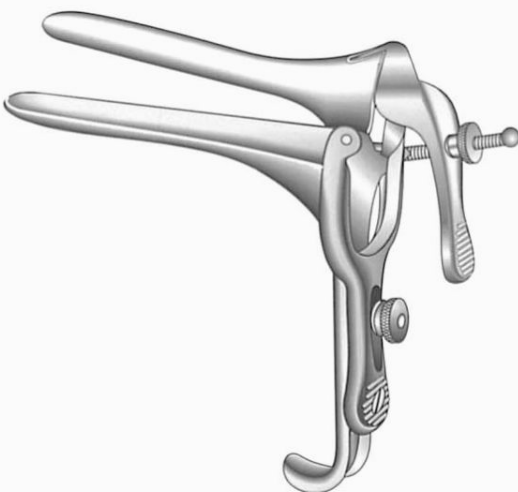

Pederson
19-164-01 75 x 13 mm
19-164-02 100 x 22 mm
19-164-03 120 x 25 mm



Graves
19-172-01 75 x 20 mm
19-172-02 95 x 35 mm
19-172-03 115 x 35 mm



19-135-07
19-137-07
7 mm
Fig. 1



19-135-08
19-137-08
8 mm
Fig. 2



19-135-09
19-137-09
9 mm
Fig. 3



19-135-11
19-137-11
11 mm
Fig. 4



19-135-12
19-137-12
12 mm
Fig. 5



19-135-14
19-137-14
14 mm
Fig. 6

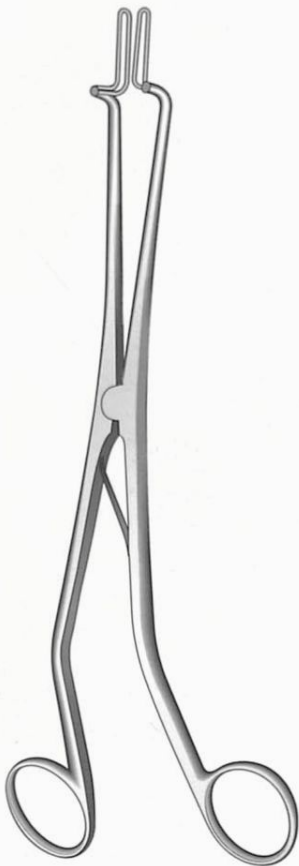

Kogan
19-125-24
24 cm / 9½"



Sims
19-162-32
32 cm / 12½"
Malleable



Sims Uterine Curettes
Sharp

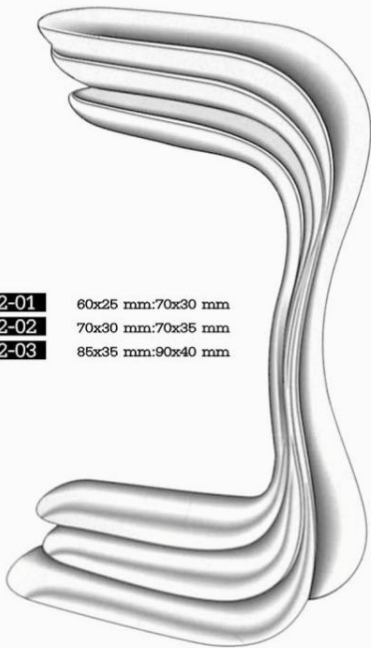

- 19-182-01** 60x25 mm:70x30 mm
- 19-182-02** 70x30 mm:70x35 mm
- 19-182-03** 85x35 mm:90x40 mm

Sims
19-182-00

Fig.	a mm	b mm	slightly concave.
1	55	35	19-188-01
2	58	35	19-188-02
3	115	35	19-188-03
1	55	35	19-189-01
2	58	35	19-189-02
3	115	35	19-189-03
4	160	45	19-189-04
1	55	60	19-190-01
2	58	60	19-190-02
3	115	60	19-190-03
4	160	60	19-190-04

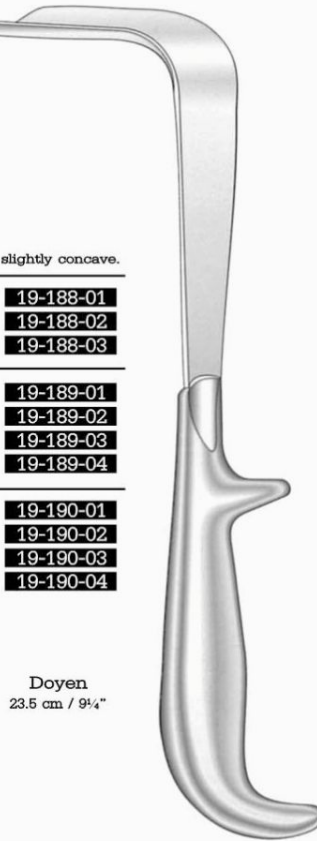

Doyen
23.5 cm / 9 1/4"

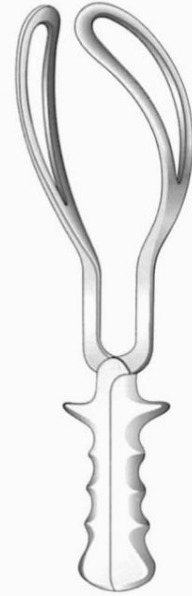

Simpson-Braun
20-102-30 30 cm / 12"
20-102-36 36 cm / 14"

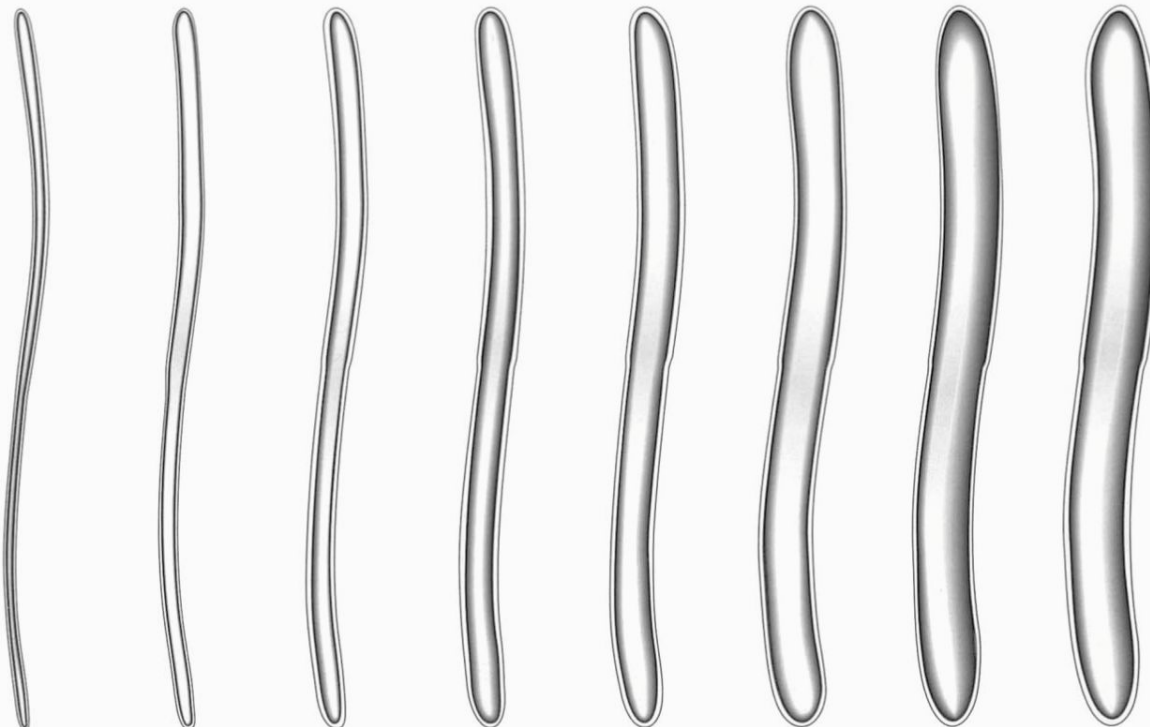

- 19-157-04** 3 mm Ø 4 mm Ø
- 19-157-06** 5 mm Ø 6 mm Ø
- 19-157-08** 7 mm Ø 8 mm Ø
- 19-157-10** 9 mm Ø 10 mm Ø
- 19-157-12** 11 mm Ø 12 mm Ø
- 19-157-14** 13 mm Ø 14 mm Ø
- 19-157-16** 15 mm Ø 16 mm Ø
- 19-157-04** 17 mm Ø 18 mm Ø

Uterine Dilators
19-157-00
Set of 8
In artificial leather pouch

Otology & Rhinology



Hartmann-Halle
15 cm / 6"

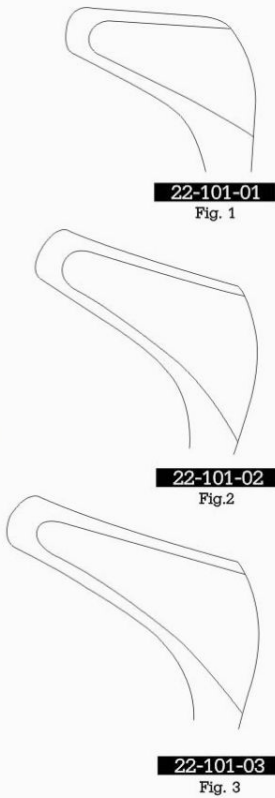

22-101-01

Fig. 1

22-101-02

Fig. 2

22-101-03

Fig. 3



Troeltsch

22-112-15

15 cm / 6"

22-112-18

18 cm / 7"



Gruenwald (Jansen)

22-113-20

20 cm / 8"

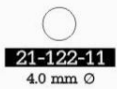

21-122-11

4.0 mm Ø

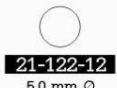

21-122-12

5.0 mm Ø

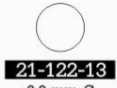

21-122-13

6.0 mm Ø

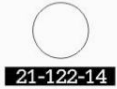

21-122-14

7.5 mm Ø



Hartmann
for adults

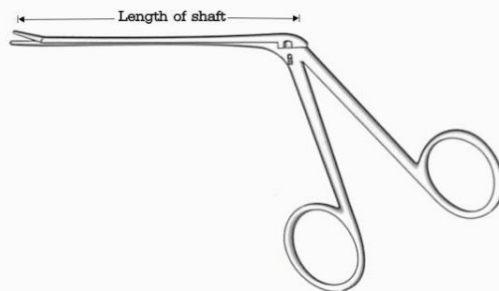

Hartmann Alligator

21-136-08 8.5 cm / 3 1/2"

21-136-14 14 cm / 5 1/2"

21-136-16 16.5 cm / 6 1/2"



21-174-00 50 ml

21-174-03 75 ml

21-174-04 100 ml

Ear Syringe, Complete

Rhinology

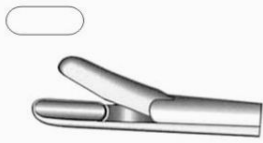

22-127-12



22-128-12

Takahashi
19 cm / 7 1/2"

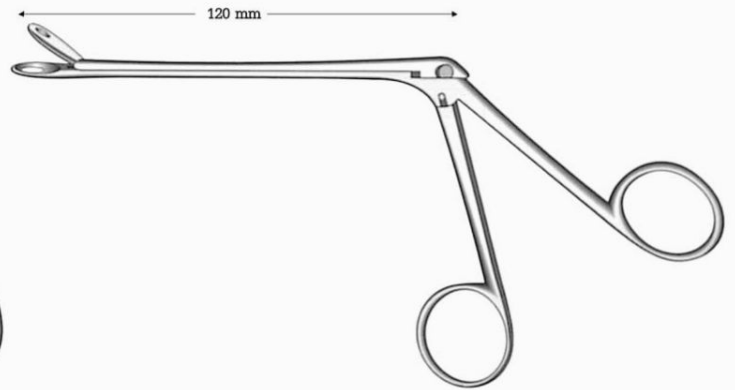
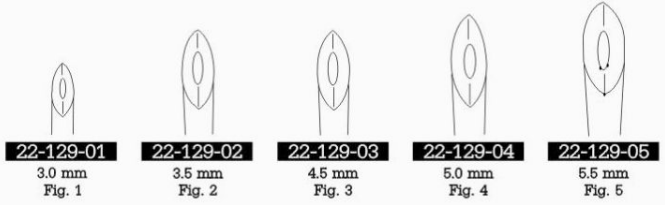

Weil-Blakesley
19 cm / 7 1/2"

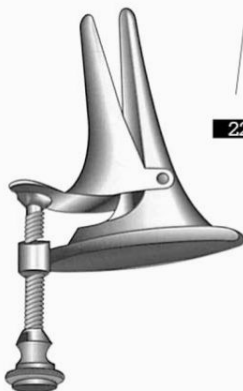

Voltolini



Killian
13 cm / 5"

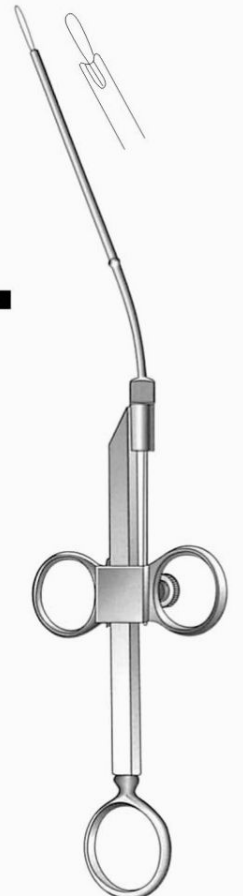
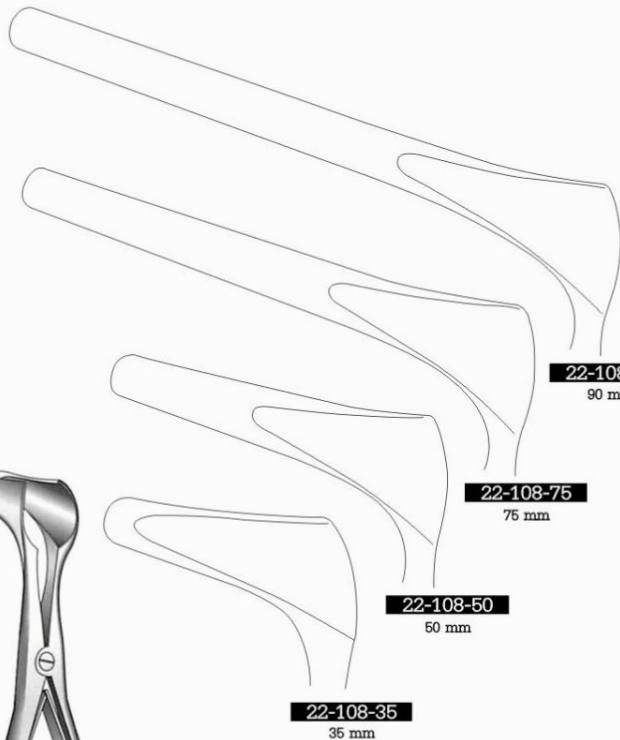

Krause
22-110-26
26 cm / 10 1/4"

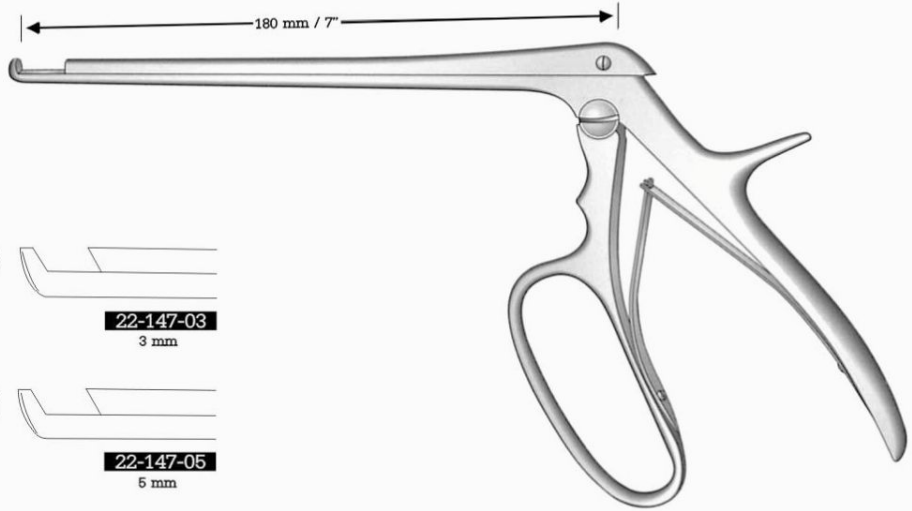
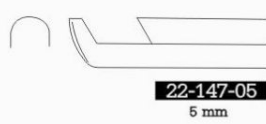
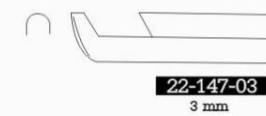
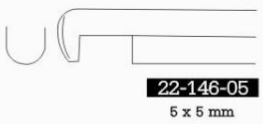
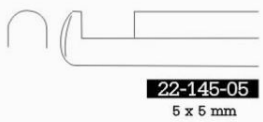
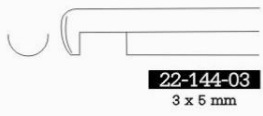
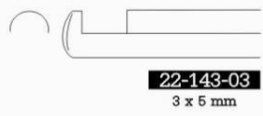

Ferris-Smith-Kerrison



Beckmann
22 cm / 8 3/4"



Cottle-Walsham
22-207-23
23 cm / 9"

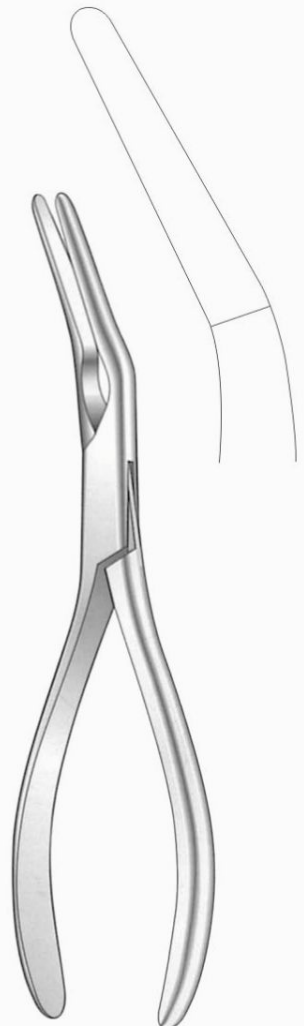

Asch
22-208-23
23 cm / 9"

Ophthalmology



Graefe
11 cm / 4 1/4"



24-192-01



24-193-01



24-194-01



24-192-02



24-193-02



24-194-02



Stevens
11 cm / 4 1/4"



24-195-10



24-196-10



24-197-10



24-198-10
1:2 Teeth



24-199-10
1:2 Teeth



24-200-10
1:2 Teeth

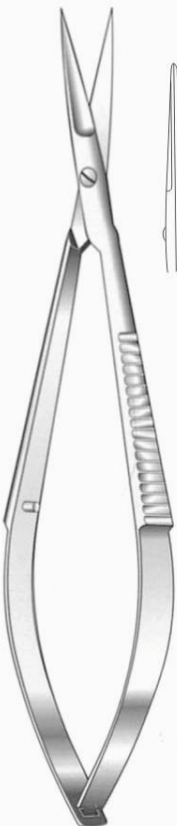

Noyes
12 cm / 4 3/4"



24-268-12
Fig. 01



24-269-12
Fig. 02



24-270-12
Fig. 03

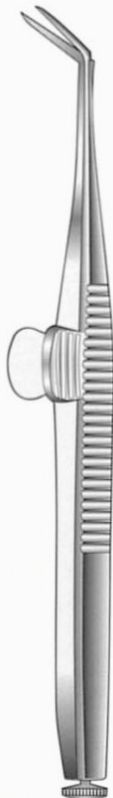

Wecker
11.5 cm / 4 1/2"

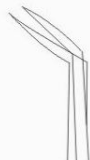

24-277-11



24-278-11



24-279-11



24-275-08
8 cm / 3 1/4"
Curved



Vannas
24-274-08
8 cm / 3 1/4"
Straight

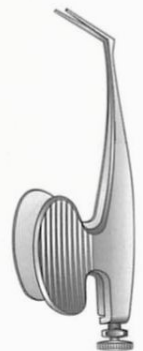

Barraquer
24-276-05
6.5 cm / 2 1/4"
Straight

Ophthalmology



Ayer
24-242-09
9 cm / 3½"



Lambert
24-244-09
9 cm / 3½"



Desmarres
9 cm / 3½"



24-247-09



24-248-09



24-249-09



24-284-14
14 cm / 5½"
Smooth



24-284-18
18 cm / 7"
Mini Profile



24-284-21
21 cm / 8½"
Mini Profile



24-285-14
14 cm / 5½"
Smooth



24-285-18
18 cm / 7"
Mini Profile



24-285-21
21 cm / 8½"
Mini Profile



Castroviejo



Castroviejo
24-286-13
13 cm / 5"



Smooth



Barraquer
24-287-13
13 cm / 5"
With lock



Smooth

TC Instruments



25-126-12

25-127-12
1:2 Teeth

Adson
12 cm / 4 3/4"
Normal Profile



Cushing
25-128-18
18 cm / 7"



25-130-17

25-131-17
1:2 Teeth

Bonney
17 cm / 6 3/4"
Normal Profile



25-133-15
15 cm / 6"

25-134-18
18 cm / 7"

25-135-20
20 cm / 8"

25-136-25
25 cm / 10"

Potts Smith

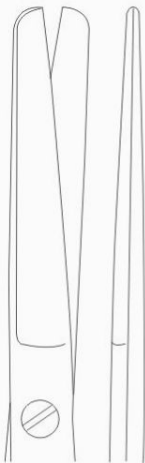
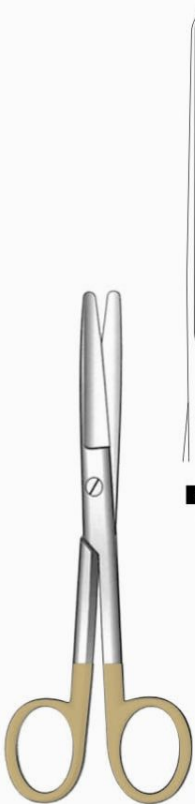

25-101-14
Straight



25-102-14
Curved

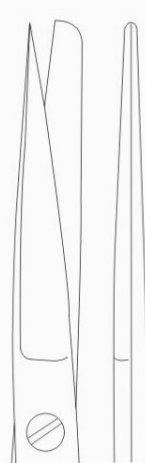
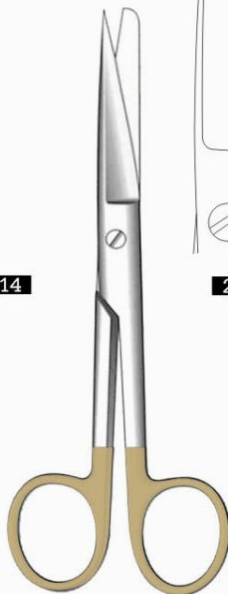

25-103-14
Straight



25-104-14
Curved

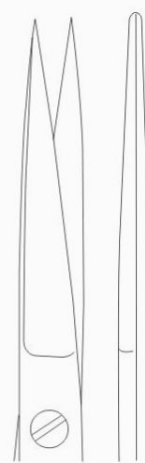
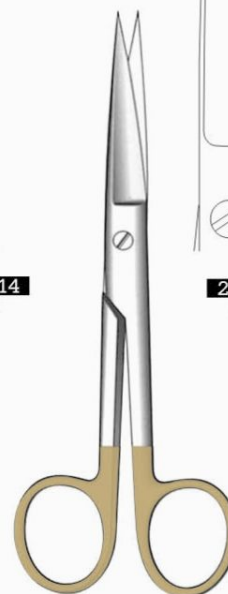

25-103-14
Straight



25-106-14
Curved

Standard
14 cm / 5 1/2"

Standard
14 cm / 5 1/2"

Standard
14 cm / 5 1/2"

TC Instruments

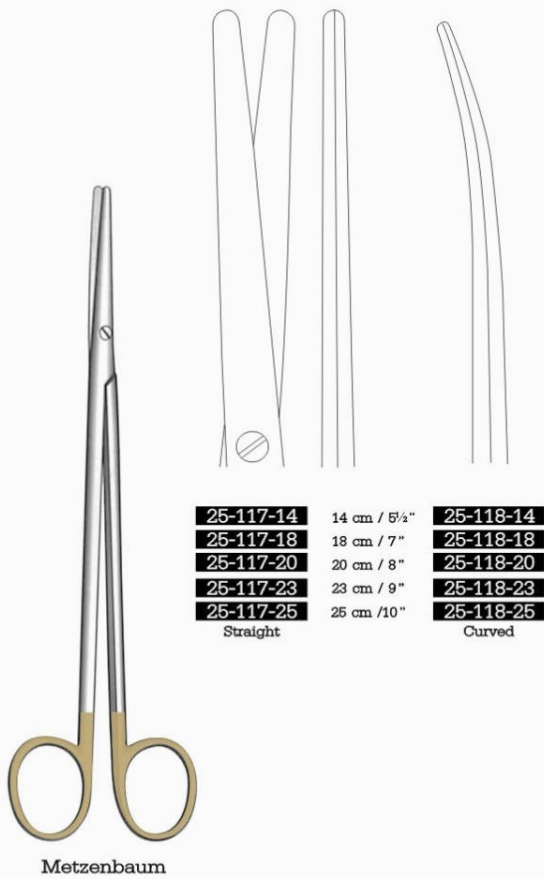
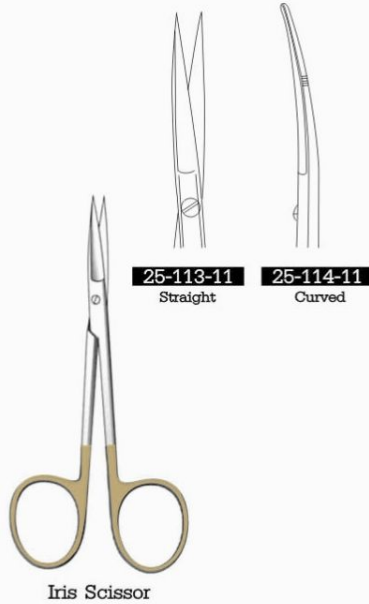
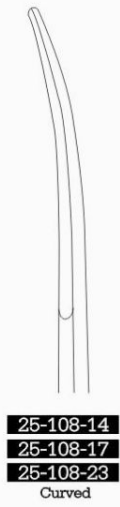
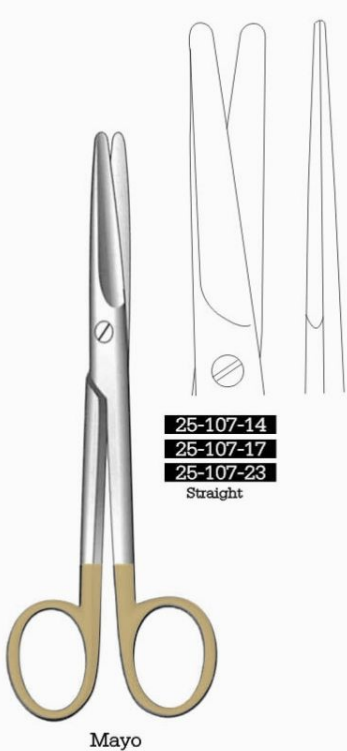

TC Instruments

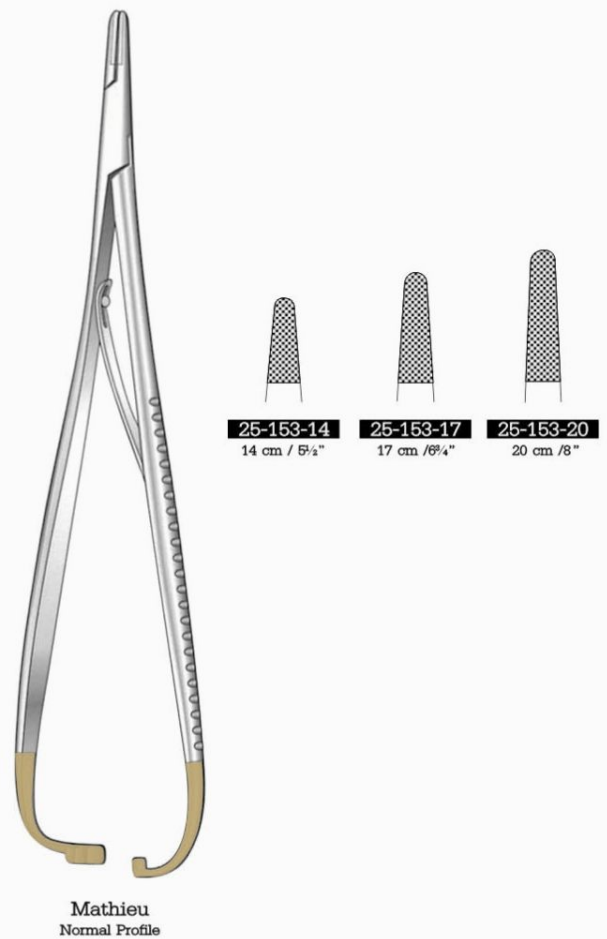
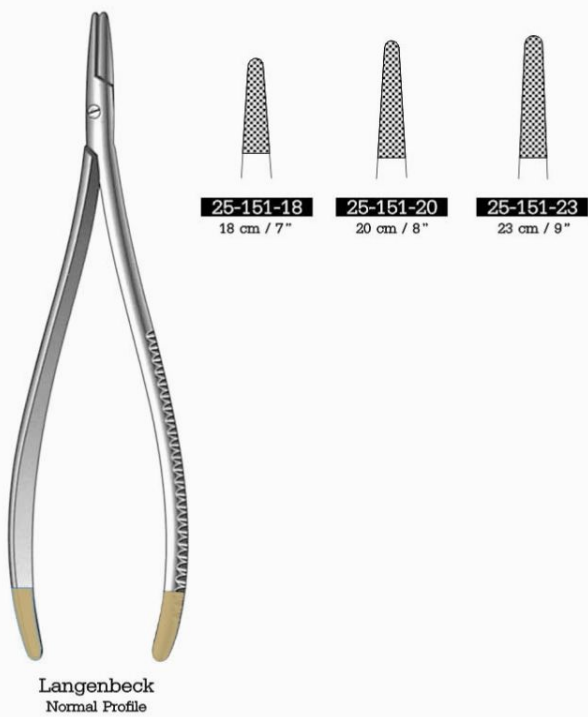
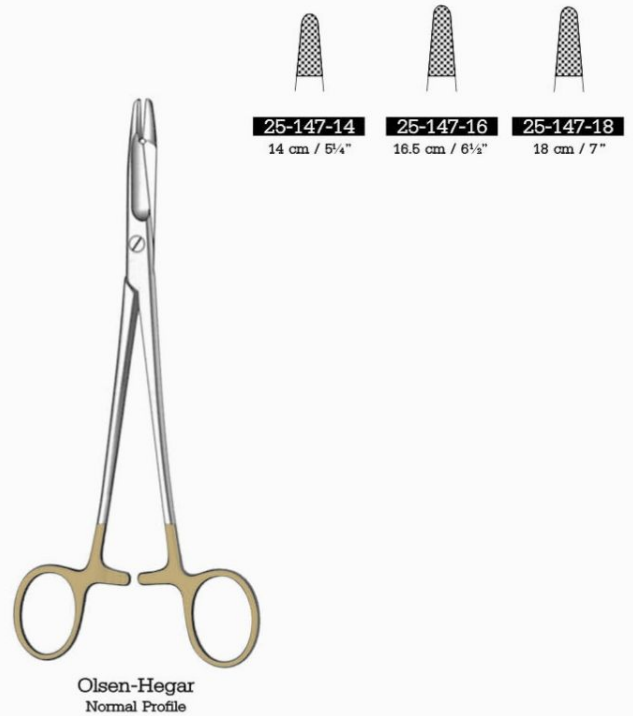
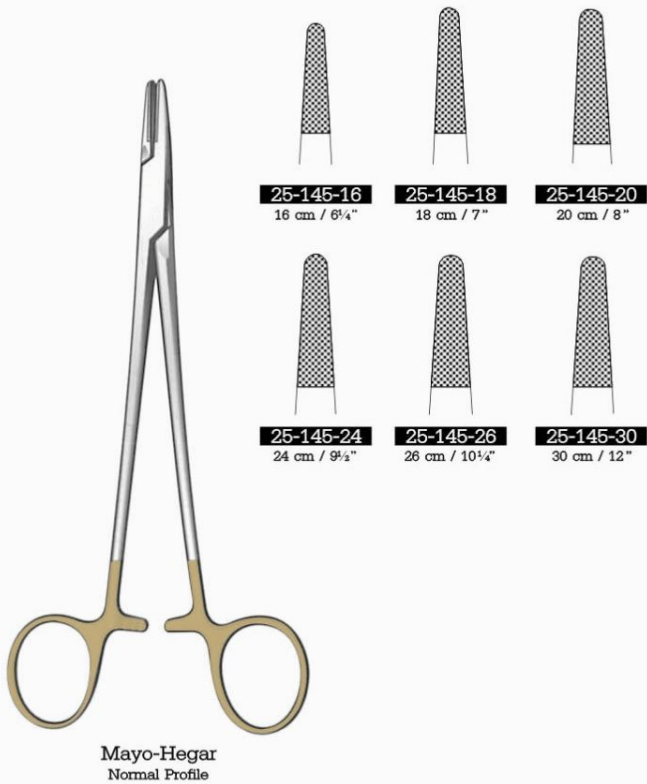

Dental Forceps

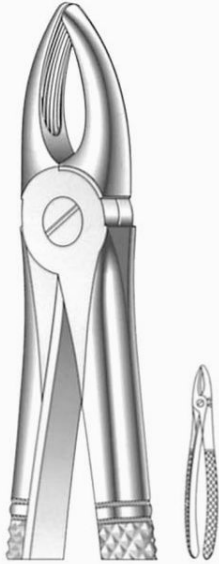

Upper Centrals
3000
Fig. 1

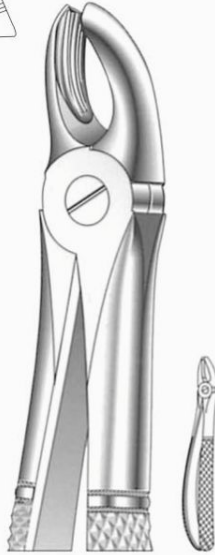

Upper Molars
3007
Fig. 17

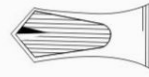

Lower Molars
3013
Fig. 22

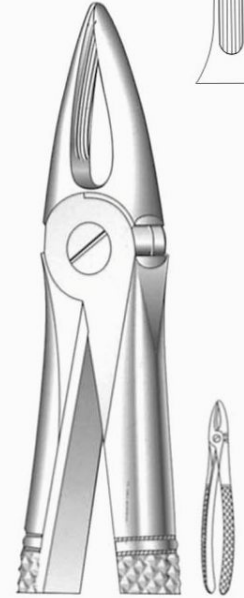

Upper Roots
3016
Fig. 29

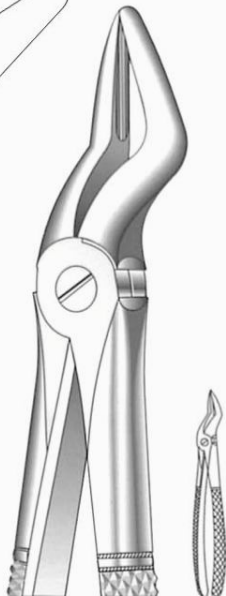
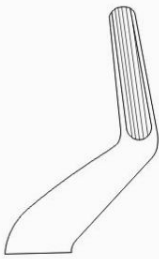

Upper Roots
3024
Fig. 51



Lower Roots
3033
Fig. 74

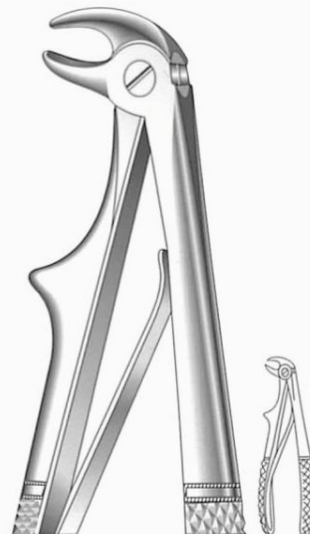

Lower Incisors
3059
Fig. 5

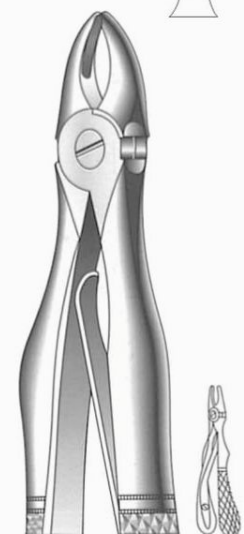

Upper Incisors
3062
Fig. 137

Dental Instruments



Apical



3099
Fig. 301



3100
Fig. 304



3132
Fig. 11L



3133
Fig. 11R



Cryer
2110
Fig. 27



Cryer
3111
Fig. 28



Winter



3136
Fig. 13L



3137
Fig. 13R



Coupland
14 cm / 5½"



3114
2 mm



3115
2.5 mm



3116
3 mm



Bein



3124
3 mm



3125
3 mm



3126
3 mm



3127
4 mm



3128
4 mm



3129
4 mm

Impression Trays & Syringes



Amalgam Carrier
3342



Amalgam Carrier
3343



3361



3362

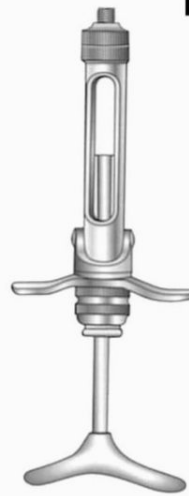

Dental Syringe
3360A 1.8 ml
3360B 2.2 ml

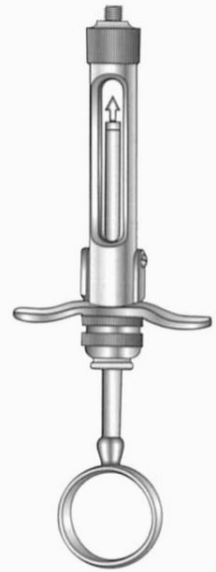

Dental Syringe
3363A 1.8 ml
3363B 2.2 ml



Perforated		Size
3470	L1	XXS
3471	L2	XS
3472	L3	S
3473	L4	M
3474	L5	L

Lower



Perforated		Size
3475	U1	XXS
3476	U2	XS
3477	U3	S
3478	U4	M
3479	U5	L

Upper



Solid		Size
3480	L1	XXS
3481	L2	XS
3482	L3	S
3483	L4	M
3484	L5	L

Lower



Solid		Size
3485	U1	XXS
3486	U2	XS
3487	U3	S
3488	U4	M
3489	U5	L

Lower

Sterilization & Instrument Boxes

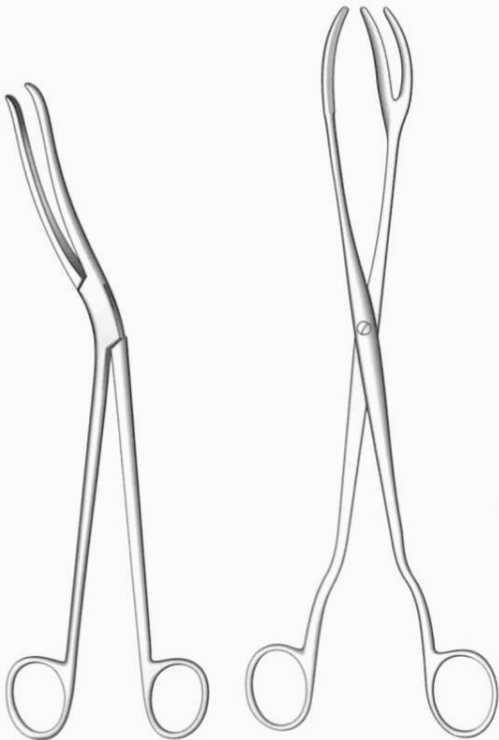

Cheattle
26-101-27
27 cm / 10 3/4"

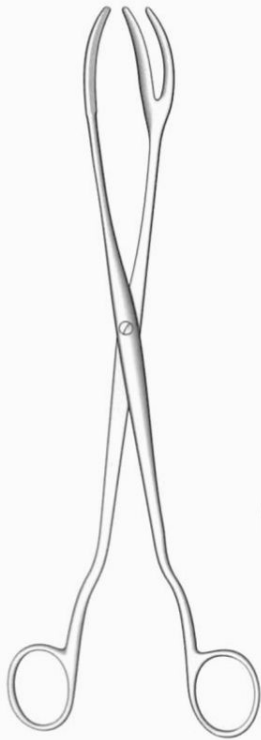

26-102-20 20 cm / 8"
26-102-30 30 cm / 12"

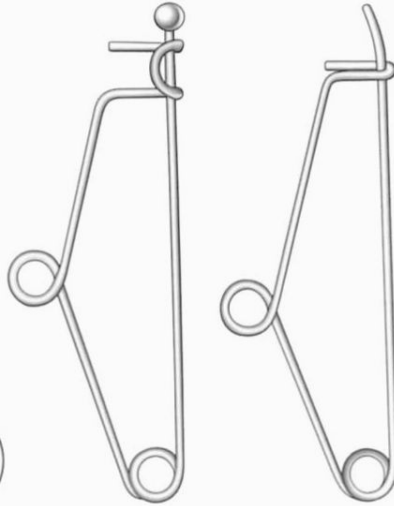

Bunt (Mayo)
26-105-01
14 cm / 5 1/2"
With ball stop

Bunt (Mayo)
26-105-01
14 cm / 5 1/2"



Sterilizing Drums

	Dia. x Geight
26-105-01	80 x 80 mm
26-105-02	120 x 120 mm
26-105-03	190 x 140 mm
26-105-04	190 x 200 mm
26-105-05	160 x 120 mm
26-105-06	240 x 120 mm
26-105-07	240 x 160 mm
26-105-08	240 x 240 mm
26-105-09	290 x 120 mm
26-105-10	290 x 160 mm
26-105-11	290 x 240 mm
26-105-12	340 x 160 mm
26-105-13	340 x 240 mm
26-105-14	390 x 145 mm
26-105-15	390 x 200 mm
26-105-16	390 x 290 mm



Style A

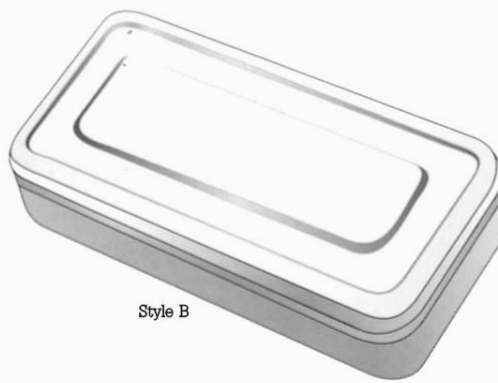

Style B

Instrument Box

Style "A"	L x W x D
26-106-01	180 x 90 x 35 mm
26-106-02	200 x 100 x 35 mm
26-106-03	200 x 100 x 50 mm
26-106-04	220 x 120 x 50 mm
26-106-05	250 x 150 x 50 mm
26-106-06	300 x 150 x 60 mm

Instrument Box

Style "B"	L x W x D
26-106-01	180 x 90 x 35 mm
26-106-02	180 x 80 x 50 mm
26-106-03	200 x 100 x 35 mm
26-106-04	200 x 100 x 50 mm
26-106-05	230 x 100 x 50 mm
26-106-06	250 x 120 x 50 mm
26-106-07	250 x 150 x 50 mm
26-106-08	300 x 250 x 50 mm
26-106-09	300 x 150 x 60 mm
26-106-10	350 x 180 x 70 mm

Round Bowls, Jars & Instrument Trays

Bone Surgery



Instrument Trays

	L x W x D
26-108-01	150 x 100 x 25 mm
26-108-01	200 x 150 x 38 mm
26-108-01	250 x 200 x 50 mm
26-108-01	300 x 250 x 50 mm
26-108-01	355 x 205 x 50 mm
26-108-01	405 x 305 x 50 mm
26-108-01	460 x 300 x 50 mm



Instrument Trays

	L x W x D
26-109-01	230 x 180 x 10 mm
26-109-02	300 x 150 x 10 mm
26-109-03	200 x 200 x 10 mm
26-109-04	370 x 250 x 10 mm
26-109-05	320 x 280 x 10 mm

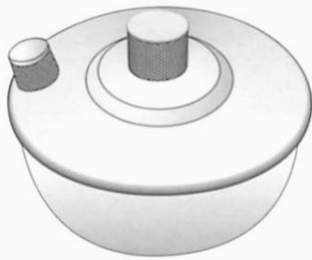

Spirit Lamp
26-110-01
120 cc, Double bolt



Round Bowls

	Dia. x Height	Capacity
26-111-01	167 x 62 mm,	0.9 L
26-111-02	200 x 75 mm,	1.4 L
26-111-03	230 x 82 mm,	2.2 L
26-111-04	261 x 94 mm,	3.0 L
26-111-05	292 x 103 mm,	4.0 L
26-111-06	328 x 111 mm,	5.7 L



Forcep Jars

	Dia. x Height	
26-112-01	30 x 90 mm	26-112-21
26-112-02	50 x 100 mm	26-112-22
26-112-03	50 x 130 mm	26-112-23
26-112-04	50 x 175 mm	26-112-24
26-112-05	75 x 100 mm	26-112-25
26-112-06	75 x 130 mm	26-112-26
26-112-07	75 x 175 mm	26-112-27
26-112-08	100 x 175 mm	26-112-28
26-112-09	100 x 200 mm	26-112-29
	without lid	with lid

Containers



Medicine Cup
26-113-25
25 cc



Medicine Cup
26-114-50
50 cc



Medicine Cup
26-115-90
90 mm dia. x 90 mm height



Medicine Cup
26-116-80
80 mm dia. x 90 mm height



Dressing Jars

	Dia. x Height
26-117-01	75 x 75mm
26-117-02	100 x 100mm
26-117-03	125 x 125mm
26-117-04	150 x 150mm
26-117-05	180 x 180mm
26-117-06	200 x 200mm
26-117-07	250 x 250mm
26-117-08	330 x 330mm



Kidney Dish

26-118-01	150 mm
26-118-02	170 mm
26-118-03	200 mm
26-118-04	250 mm
26-118-05	300 mm



Solution Bowl

	Dia. x Height
26-119-01	50 x 25 mm
26-119-02	80 x 40 mm
26-119-03	100 x 45 mm
26-119-04	115 x 50mm
26-119-05	150 x 60mm
26-119-06	200 x 90mm
26-119-07	250 x100 mm
26-119-08	300 x115 mm

Section II

Medical Disposable Products

A large, faint, light grey watermark of the igsar GROUP logo is visible in the background, centered behind the main title.

DISPOSABLE SYRINGES/NEEDLES

Item	Product Code	Size	Packing	Unit	Unit/CTN
Disposable luer slip syringe	SYC-SY-DIS-01	3ml with 23Gx1" needle	Polybag, 100pcs/box Opt: Blister	pc	2700
	SYC-SY-DIS-02	5ml with 22Gx1 1/4" needle			2400
	SYC-SY-DIS-INS-01	Insulin syringe with 29Gx1/2" fixed needle			3000



Item	Product Code	Size	Packing	Unit	Unit/CTN
Hypodermic needle	SYC-N-01	18Gx1 1/2"	Blister, 100pcs/box	pc	5000
	SYC-N-02	21Gx1 1/2"			5000
	SYC-N-03	22Gx1 1/4"			5000
	SYC-N-04	23Gx1"			5000
	SYC-N-05	24Gx1			5000



CANNULAS

Product Code	Type	Size OD(mm) Gauge		Color Code	Length Availability					
					20 3/4"	25 1"	32 1 1/4"	38 1 1/2"	50 2"	64 2 1/2"
SYC-C-P-01	Pen type	0.7	24G	yellow	Yes					
SYC-C-P-02		0.9	22G	blue		Yes				
SYC-C-P-03		1	20G	pink			Yes		Yes	
SYC-C-P-04		1.2	18G	green			Yes	Yes	Yes	
SYC-C-P-05		1.7	16G	grey					Yes	Yes
SYC-C-P-06		2	14G	orange					Yes	
SYC-C-B-01	Butterfly type	0.7	24G	yellow	Yes					
SYC-C-B-02		0.9	22G	blue		Yes				
SYC-C-B-03		1	20G	pink			Yes		Yes	
SYC-C-B-04		1.2	18G	green			Yes	Yes	Yes	
SYC-C-B-05		1.7	16G	grey					Yes	Yes
SYC-C-B-06		2	14G	orange					Yes	
SYC-C-S-01	Normal/ Safety type	0.7	24G	yellow	Yes					
SYC-C-S-02		0.9	22G	blue		Yes				
SYC-C-S-03		1	20G	pink			Yes			
SYC-C-S-04		1.2	18G	green			Yes	Yes		

100 Pcs Per Bag
50 Bags/Ctn



DISPOSABLE GLOVES

Product	Feature	Product Code	Product Description
Sterile Surgical latex gloves	straight with powder, PAIR	L-G-S-01	6 (260,77)+-5
		L-G-S-02	6.5 (260,83)+-5
		L-G-S-03	7 (270,89)+-5
		L-G-S-04	7.5 (270,95)+-5
		L-G-S-05	8 (270,102)+-5

Product	Feature	Product Code	Product Description
Non-sterile Latex Examination gloves	S,M,L, with powder /PC	L-G-E-01	S (235, 80)+-5
		L-G-E-01	M (240,90)+-5
		L-G-E-01	L (240,105)+-5
		L-G-E-01	XL (245,110)+-5

Product	Feature	Product Code	Product Description
Disposable Clear Vinyl Glove	Powder Free/Powdered	L-G-V-01	M# =4.3g+_0.3



Various Specialized sizes, packaging and specifications (with or without powder) available as per requirement of the client

DISPOSABLE CATHETERS

Product	Product Code	Product Description
LATEX FOLEYS CATHETER (SILICON COATED)	L-C/L-01	2 Way pediatric 6/8/10FR Balloon:3/5ml
	L-C/L-02	2 Way standard 12FR-22FR Balloon:5/10/30ml
	L-C/L-03	2 Way standard 24FR-30FR Balloon:30ml
	L-C/L-04	3 Way standard 14FR-22FR Balloon:30ml
	L-C/L-05	3 Way standard 24FR-26FR Balloon:30ml

Product	Product Code	Product Description
SILICON FOLEY CATHETER	L-C/S-01	2 Way pediatric 8FR-10FR Balloon:3/5ml
	L-C/S-02	2 Way standard 12FR-18FR Balloon:5/10/15ml
	L-C/S-03	2 Way standard 20FR-24FR Balloon:5/10/15/30ml
	L-C/S-04	3 Way standard 16FR-24FR Balloon:30ml



Various other types of Catheters and Condom, with or without value added features available. Products with or without Silicon Coating also available

HOSPITAL BED SHEETS

Fabric Composition	Construction	Product Code	Size
100% Cotton	20x20/70x60 - 155 GSM	HT-BS-C-01	250 X 180cm
		HT-BS-C-02	270 X 180cm
		HT-BS-C-03	200 X 180cm
	20x20/52x48 - 120 GSM	CH-HT-BS-C-01	250 X 180cm
		CH-HT-BS-C-02	270 X 180cm
		CH-HT-BS-C-03	200 X 180cm

50/50 Polyester-Cotton	20x20/70x60 - 155 GSM	Product Code	Size
		HT-BS-PC-01	250 X 180cm
		HT-BS-PC-02	270 X 180cm
		HT-BS-PC-03	200 X 180cm
	20x20/52x48 - 120 GSM	CH-HT-BS-PC-01	250 X 180cm
		CH-HT-BS-PC-02	270 X 180cm
		CH-HT-BS-PC-03	200 X 180cm



Available in White & Green Colors. Other Colors also available.

Available with or without quilt & pillow covers.

Fabric Composition CVS 60/40 ; PC 65/35 & higher GSM also available

HOSPITAL TOWELS

Weight	Product Code	Size
--------	--------------	------

250 GSM		
	HT-HT-250-01	30x30 cm
	HT-HT-250-02	30x50 cm
	HT-HT-250-03	40x70 cm
	HT-HT-250-04	50x90 cm
	HT-HT-250-05	50x100 cm
	HT-HT-250-06	60x120 cm
	HT-HT-250-07	100x150 cm



320 GSM		
	HT-HT-320-01	30x30 cm
	HT-HT-320-02	30x50 cm
	HT-HT-320-03	40x70 cm
	HT-HT-320-04	50x90 cm
	HT-HT-320-05	50x100 cm
	HT-HT-320-06	60x120 cm
	HT-HT-320-07	100x150 cm

450 GSM		
	HT-HT-450-01	30x30 cm
	HT-HT-450-02	30x50 cm
	HT-HT-450-03	40x70 cm
	HT-HT-450-04	50x90 cm
	HT-HT-450-05	50x100 cm
	HT-HT-450-06	60x120 cm
	HT-HT-450-07	100x150 cm

550 GSM		
	HT-HT-550-01	30x30 cm
	HT-HT-550-02	30x50 cm
	HT-HT-550-03	40x70 cm
	HT-HT-550-04	50x90 cm
	HT-HT-550-05	50x100 cm
	HT-HT-550-06	60x120 cm
	HT-HT-550-07	100x150 cm

Available in White & Green Colors. Other Colors are also available. Customized Sizes also possible

ABSORBENT CLOTH (OPERATION THEATER)

Fabric Composition	Size / Construction	Product Code	Color/Remarks
100% Cotton/Towel (Fast Washable)	100x 120 cm 450 GSM	HT-ABSCOT-01	Green/Hole/Slit
100% Cotton	20 x20 / 52 x48 100 x 120 cm	CH-HT-ABSCOT-01	Vat Dyed / Different Colors Hole/Slit
	60 x80 cm	CH-HT-ABSCOT-02	
	50 x50 cm	CH-HT-ABSCOT-03	



PATIENT'S GOWNS

Fabric Composition	Construction	Product Code	Size	Color	Style
100 % Cotton 110 GSM	20x20 / 70 x 60	CH-HT-PG-01	European S, M, L, XL, XXL / Half or Quarter Sleeves	White/ Vat Dye	Front/Back/ Side Opening
100% Cotton 155 GSM	20x20 / 70 x 60	CH-HT-PG-02	European S, M, L, XL, XXL / Half or Quarter Sleeves	White/ Vat Dye	Front/Back/ Side Opening
100% Cotton 175 GSM	20x20 / 70 x 60	HT-PG-01	European S, M, L, XL, XXL / Half or Quarter Sleeves	White/ Vat Dye	Front/Back/ Side Opening



SCRUB SUITS

Scrub Suits	100% Cotton					
	White	White	Dyed	Dyed	Printed	Printed
SIZES	110gsm	175gsm	110gsm	175gsm	110gsm	175gsm
SX	CH-HT-SS-C-W- 01	HT-SS-C-W-01	CH-HT-SS-C-D-01	HT-SS-C-D-01	CH-HT-SS-C-P-01	HT-SS-C-P-01
S	CH-HT-SS-C-W- 02	HT-SS-C-W-02	CH-HT-SS-C-D-02	HT-SS-C-D-02	CH-HT-SS-C-P-02	HT-SS-C-P-02
M	CH-HT-SS-C-W- 03	HT-SS-C-W-03	CH-HT-SS-C-D-03	HT-SS-C-D-03	CH-HT-SS-C-P-03	HT-SS-C-P-03
L	CH-HT-SS-C-W- 04	HT-SS-C-W-04	CH-HT-SS-C-D-04	HT-SS-C-D-04	CH-HT-SS-C-P-04	HT-SS-C-P-04
XL	CH-HT-SS-C-W- 05	HT-SS-C-W-05	CH-HT-SS-C-D-05	HT-SS-C-D-05	CH-HT-SS-C-P-05	HT-SS-C-P-05
XXL	CH-HT-SS-C-W- 06	HT-SS-C-W-06	CH-HT-SS-C-D-06	HT-SS-C-D-06	CH-HT-SS-C-P-06	HT-SS-C-P-06
XXXL	CH-HT-SS-C-W- 07	HT-SS-C-W-07	CH-HT-SS-C-D-07	HT-SS-C-D-07	CH-HT-SS-C-P-07	HT-SS-C-P-07

Available in GSM 190. Customized GSM also possible.
Also available in PC 65/35 & CVC 60/40 Compositions



DOCTOR / LAB COATS

Fabric Composition	Weight	Size	Remarks:
100% Cotton	180 GSM	European S,M,L,XL,XXL	Long Sleeves Closed with Snap buttons and Velcro tape; 1 chest pocket & 2 lower pockets

Male/Female Type Also available PC 65/35 2x1 & CVC 60/40
2x1 Twill White Also available in 145 & 210 GSM

NON-WOVEN PRODUCTS

SURGICAL GOWNS

Product Code	Products name	GSM	Description/Size	Packing
NW-G-01	Surgical/isolation gown	18	115x137cm, elastic cuffs	10pcs/bag, 200pcs/ctn

FACE MASKS

Product Code	Products name	GSM	Description/Size	Packing
NW-M-3-01	3ply Face mask with ties	18gsm PP + 20gsm Melt blown PP + 25gsm PP	17.5*9.5cm	50pcs/box, 2000pcs/ctn
NW-M-2-01	2ply Face mask with ties	18gsm PP + 25gsm PP	17.5*9.5cm	50pcs/box, 2000pcs/ctn

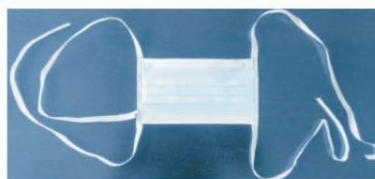

SURGICAL CAPS

Product Code	Products name	GSM	Description/Size	Packing
NW-C-BT-01	Surgical cap with back fixed ties	16	64x13cm	100pcs/bag, 2000pcs/ctn
NW-C-BT-02	Surgical cap with back fixed ties	20	64x13cm	100pcs/bag, 2000pcs/ctn
NW-C-B-01	Bouffant Cap	10	18 inches, 2 Ply	100 Pcs/Polybag, 2000 pcs/case
NW-C-B-02	Bouffant Cap	20	21 inches, 2 Ply	100 Pcs/Polybag, 2000 pcs/case



SHOE COVERS

Product Code	Products name	GSM	Description/ Size	Packing
NW-SC-N-01	shoe cover, Normal	25	18*40cm	100pcs/bag, 2000pcs/ctn
NW-SC-AN-01	shoe cover, anti - skid/non slip	25	18*40cm	100pcs/bag, 2000pcs/ctn
NW-SC-N-02	shoe cover, Normal	30	18*40cm	100pcs/bag, 2000pcs/ctn
NW-SC-AN-02	shoe cover, anti - skid/non slip	30	18*40cm	100pcs/bag, 2000pcs/ctn



Higher/Lower GSM weights also possible All products available in Blue, Green, White and other different colors

GAUZE SWABS / SPONGES Sterilized (USP-IV/BPC)

8 Ply / folded / Each Gauze Piece net weight: 1.3 gm

Single Piece

Spec	Product Code	Gauze Size
34 Picks; Single gauze Piece	SC-G-ST-SING-10	10 cm x 10 cm

Each Single Gauze Piece packed in Breathable Paper Packet.
12 Packed Pieces or Packets in 1 Paper Box.



Ten Pieces Packet

Spec	Product Code	Size
8 Ply; 34 Picks	SC-G-ST-10-05	5 cm x5 cm
	SC-G-ST-10-7.5	7.5 cm x7.5cm
	SC-G-ST-10-10	10 cmx10 cm
	SC-G-ST-10-15	15 cm x15 cm

Each packet contains 10 gauze pieces. Each Packet is made of Breathable paper.
10 packets in each paper box. Total 100 gauze pieces in each box.

Each Box gross weight 200 gm

Customized Picks i.e 28 and other constructions also possible



GAUZE SWAB / SPONGE Non Sterilized (USP-IV/BPC)

8 Ply / folded / Each Gauze Piece net weight: 1.3 gm

Compressed Pack

Product	Specification	Gauze Size
SC-G-US-C-7.5	8 Ply / 34 Picks	7.5 cm x 7.5 m
SC-G-US-C-10	8 Ply / 34 Picks	10 cm x 10 cm

100 gauze pieces compressed in one poly bag.
Packing with Less number of gauzes & bottom pull window also available



Ten Pieces Packet

Product	Specification	Gauze Size
SC-G-8/17-01	8 Ply / 34 Picks	5 cm x 5 cm
SC-G-8/17-01	8 Ply / 34 Picks	7.5cm x 7.5 cm
SC-G-8/17-01	8 Ply / 34 Picks	10 cm x 10 cm

Customized constructions i.e. 28 etc also available.



GAUZE BANDAGE

Non Sterile (USP/BPC)

Specification	Product Code	Size
56 Picks	SC-B-5	5 cm x 3 Metre
56 Picks	SC-10	10 cm x 3 Metre
56 Picks	SC-15	15 cm x 3 Metre

Non Sterile Gauze Bandages; Packed in one dozen pieces packing;
Packet is made of Poly PP.



SPECIAL DRESSINGS

BPC/USP

Product Code	Dressings	Pack
SC-PG-01	Paraffin Gauze Dressing	Tin of 30
SC-TU-01	Para-Tulle (Wound dressing) Chlorhexidine Acetate 0.5%	Box of 10

Both size 10 x 10cm
Customization also possible

ABSORBENT COTTON WOOL

BPC /USP

Product Code	Wt
SC-COT-100	100 gm
SC-COT-200	200 gm
SC-COT-400	400 gm
SC-COT-500	500 gm

Customization also possible



GAUZE CLOTH / ROLL

BPC /USP

Product Code	Size
SC-GZCLOTH-20	1 x 20 Metre

Customization also possible



ABDOMINAL SPONGE/SWABS NON STERILE (USP/BPC)

Product Code	Specification	pcs/ pack	Packs /carton	pcs/ carton	carton size
SC-ABDSW/13/-NS-01	Lap sponge/Laparotomy sponge/Abdominal swabs,40'S,13 threads/mesh count 19×15				
SC-ABDSW/13/-NS-01/1	40s/19×15 30cm×30cm-4ply	5	160	800	46x50x42cm
SC-ABDSW/13/-NS-01/2	40s/19×15 30cm×30cm-6ply	5	80	400	46x50x26cm
SC-ABDSW/13/-NS-01/3	40s/19×15 30cm×30cm-8ply	5	80	400	46x50x36cm
SC-ABDSW/13/-NS-01/4	40s/19×15 30cm×30cm-12ply	5	80	400	46x56x50cm
SC-ABDSW/13/-NS-01/5	40s/19×15 45cm×45cm-4ply	5	160	800	46x56x52cm
SC-ABDSW/13/-NS-01/6	40s/19×15 45cm×45cm-6ply	5	80	400	46x56x36cm
SC-ABDSW/13/-NS-01/7	40s/19×15 45cm×45cm-8ply	5	80	400	46x62x50cm
SC-ABDSW/13/-NS-01/8	40s/19×15 45cm×45cm-12ply	5	80	400	46x62x62cm
SC-ABDSW/17/-NS-02	Lap sponge/Laparotomy sponge/Abdominal swabs,40'S,17 threads/mesh count 26×18				
SC-ABDSW/17/-NS-02/1	40s/26×18 30cm×30cm-4ply	5	160	800	46x50x42cm
SC-ABDSW/17/-NS-02/2	40s/26×18 30cm×30cm-6ply	5	80	400	46x50x26cm
SC-ABDSW/17/-NS-02/3	40s/26×18 30cm×30cm-8ply	5	80	400	46x50x36cm
SC-ABDSW/17/-NS-02/4	40s/26×18 30cm×30cm-12ply	5	80	400	46x56x50cm
SC-ABDSW/17/-NS-02/5	40s/26×18 45cm×45cm-4ply	5	160	800	46x56x52cm
SC-ABDSW/17/-NS-02/6	40s/26×18 45cm×45cm-6ply	5	80	400	46x56x36cm
SC-ABDSW/17/-NS-02/7	40s/26×18 45cm×45cm-8ply	5	80	400	46x62x50cm
SC-ABDSW/17/-NS-02/8	40s/26×18 45cm×45cm-12ply	5	80	400	46x62x62cm
SC-ABDSW/20/-NS-03	Lap sponge/Laparotomy sponge/Abdominal swabs,40'S,20 threads/mesh count 30×20				
SC-ABDSW/20/-NS-03/1	40s/30×20 30cm×30cm-4ply	5	160	800	46x25x42cm
SC-ABDSW/20/-NS-03/2	40s/30×20 30cm×30cm-6ply	5	80	400	46x25x26cm
SC-ABDSW/20/-NS-03/3	40s/30×20 30cm×30cm-8ply	5	80	400	46x25x36cm
SC-ABDSW/20/-NS-03/4	40s/30×20 30cm×30cm-12ply	5	80	400	46x28x50cm
SC-ABDSW/20/-NS-03/5	40s/30×20 45cm×45cm-4ply	5	160	800	46x28x52cm
SC-ABDSW/20/-NS-03/6	40s/30×20 45cm×45cm-6ply	5	80	400	46x28x36cm
SC-ABDSW/20/-NS-03/7	40s/30×20 45cm×45cm-8ply	5	80	400	46x31x50cm
SC-ABDSW/20/-NS-03/8	40s/30×20 45cm×45cm-12ply	5	80	400	46x31x62cm

5 Pcs / bundle in poly bag, then in Carton
All Sizes with Blue Loops & X Ray detectable thread
Customization also possible

ABDOMINAL SPONGE/SWABS STERILE (USP/BPC)



Product Code	Specification	pcs/ pack	Packs /carton	pcs/ carton	carton size
SC-ABDSW/13/-S-01	Lap sponge/Laparotomy sponge/Abdominal swabs,40'S,13 threads/mesh count 19x15				
SC-ABDSW/13/-S-01/1	40s/19x15 30cmx30cm-4ply	5	160	800	46x50x42cm
SC-ABDSW/13/-S-01/2	40s/19x15 30cmx30cm-6ply	5	80	400	46x50x26cm
SC-ABDSW/13/-S-01/3	40s/19x15 30cmx30cm-8ply	5	80	400	46x50x36cm
SC-ABDSW/13/-S-01/4	40s/19x15 30cmx30cm-12ply	5	80	400	46x56x50cm
SC-ABDSW/13/-S-01/5	40s/19x15 45cmx45cm-4ply	5	160	800	46x56x52cm
SC-ABDSW/13/-S-01/6	40s/19x15 45cmx45cm-6ply	5	80	400	46x56x36cm
SC-ABDSW/13/-S-01/7	40s/19x15 45cmx45cm-8ply	5	80	400	46x62x50cm
SC-ABDSW/13/-S-01/8	40s/19x15 45cmx45cm-12ply	5	80	400	46x62x62cm
SC-ABDSW/17/-S-02	Lap sponge/Laparotomy sponge/Abdominal swabs,40'S,17 threads/mesh count 26x18				
SC-ABDSW/17/-S-02/1	40s/26x18 30cmx30cm-4ply	5	160	800	46x50x42cm
SC-ABDSW/17/-S-02/2	40s/26x18 30cmx30cm-6ply	5	80	400	46x50x26cm
SC-ABDSW/17/-S-02/3	40s/26x18 30cmx30cm-8ply	5	80	400	46x50x36cm
SC-ABDSW/17/-S-02/4	40s/26x18 30cmx30cm-12ply	5	80	400	46x56x50cm
SC-ABDSW/17/-S-02/5	40s/26x18 45cmx45cm-4ply	5	160	800	46x56x52cm
SC-ABDSW/17/-S-02/6	40s/26x18 45cmx45cm-6ply	5	80	400	46x56x36cm
SC-ABDSW/17/-S-02/7	40s/26x18 45cmx45cm-8ply	5	80	400	46x62x50cm
SC-ABDSW/17/-S-02/8	40s/26x18 45cmx45cm-12ply	5	80	400	46x62x62cm
-SC-ABDSW/20/-S-03	Lap sponge/Laparotomy sponge/Abdominal swabs,40'S,20 threads/mesh count 30x20				
SC-ABDSW/20/-S-03/1	40s/30x20 30cmx30cm-4ply	5	160	800	46x25x42cm
SC-ABDSW/20/-S-03/2	40s/30x20 30cmx30cm-6ply	5	80	400	46x25x26cm
SC-ABDSW/20/-S-03/3	40s/30x20 30cmx30cm-8ply	5	80	400	46x25x36cm
SC-ABDSW/20/-S-03/4	40s/30x20 30cmx30cm-12ply	5	80	400	46x28x50cm
SC-ABDSW/20/-S-03/5	40s/30x20 45cmx45cm-4ply	5	160	800	46x28x52cm
SC-ABDSW/20/-S-03/6	40s/30x20 45cmx45cm-6ply	5	80	400	46x28x36cm
SC-ABDSW/20/-S-03/7	40s/30x20 45cmx45cm-8ply	5	80	400	46x31x50cm
SC-ABDSW/20/-S-03/8	40s/30x20 45cmx45cm-12ply	5	80	400	46x31x62cm

5 Pcs / bundle in poly bag, then in Carton
All Sizes with Blue Loops & X Ray detectable thread
Customization also possible

CREPE BANDAGE (USP/BPC)

Product Code	Size	Rolls/Ctn
SC-CR/E/01	4 Inches X 4.5 Metre	12rollsX40dozs/CTN
SC-CR/E/02	6 inches X 4.5 Metre	12rollsX30dozs/CTN

All sizes 75 GSM (Elastic / Cotton). Customization also possible



PLASTER OF PARIS (POP) BANDAGE (USP/BPC)

Product Code	Size	Packing
SC-POP-001	5cm x 2.7m	240rolls/ctn, ctn-size: 56x32x35cm
SC-POP-002	7.5cm x 2.7m	240rolls/ctn, ctn-size: 56x32x35cm
SC-POP-003	10cm x 2.7m	120rolls/ctn, ctn-size: 56x32x24 cm
SC-POP-004	12.5cm x 2.7m	120rolls/ctn, ctn-size: 56x32x28 cm
SC-POP-005	15cm x 2.7m	120rolls/ctn, ctn-size: 56x32x33 cm
SC-POP-006	20cm x 2.7m	60rolls/ctn, ctn-size: 56x32x23 cm
SC-POP-007	5cm x 4.5m	144rolls/ctn, ctn-size: 44x40x26cm
SC-POP-008	7.5cm x 4.5m	144rolls/ctn, ctn-size: 44x40x36cm
SC-POP-009	10cm x 4.5m	72rolls/ctn, ctn-size: 44x40x38 cm
SC-POP-010	12.5cm x 4.5m	72rolls/ctn, ctn-size: 44x40x29 cm
SC-POP-011	15cm x 4.5m	72rolls/ctn, ctn-size: 44x40x33 cm
SC-POP-012	20cm x 4.5m	36rolls/ctn, ctn-size: 44x40x23 cm



MEDICAL X-RAY FILMS

TYPE	Product Code	Description	Unit	Packing (Boxes/Carton)
Medical X-ray Film Green Sensitive	XRF-G-01	18×24cm×100NIF	box	5
	XRF-G-02	24×30cm×100NIF	box	5
	XRF-G-03	30×40cm×100NIF	box	5
	XRF-G-04	35×35cm×100NIF	box	5
	XRF-G-05	35×42.5cm×100NIF	box	5
Medical X-ray Film Blue Sensitive	XRF-B-01	18×24cm×100NIF	box	5
	XRF-B-02	24×30cm×100NIF	box	5
	XRF-B-03	30×40cm×100NIF	box	5
	XRF-B-04	35×35cm×100NIF	box	5
	XRF-B-05	35×42.5cm×100NIF	box	5

Packing: 100 NIF Sheets /box, 5 boxes/carton
Non Interleaved / Rounded Corners / Double Coated.

Smaller Sized Films, Dental Films, Processing Chemicals;
Other Radiology consumables & accessories also available

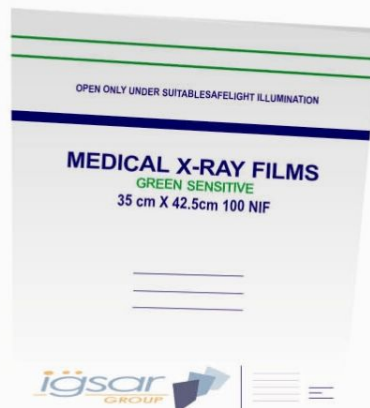

- **Fine Craftsmanship**
- **Premium Quality**
- **Delivering products to the healing hands**
- **Making All the Difference to You and Your Patients**
- **Trust the products that save lives**